

MET Single phase control and isolation transformer P: 500VA IN: 400VAC+/- 5% OUT: 230VAC

Single-phase - Control and Isolation transformers

500 VA

Isolation class T 60/B

Image

- (EN 61558)
- Protection IP20
- Isolation class T 60/B

Vicarious picture

Approvals**Input**

Input voltage	400 V AC $\pm 5\%$
Frequency	50/60 Hz
Short-circuit current	43.35 A (400 V AC)
Input current	1.36 A (400 V AC)
Inrush current	20.22 A (400 V AC)

Output

Output voltage	230 V AC
----------------	----------

General data

Standards	(EN 61558-1), (EN 61558-2-4), (EN 62041 category 0)
Test isolation voltage	4 kV (prim./sec.)
Dimensions H x W x D	112.6 x 150 x 146 mm
Fixing centers a x b x c	90 x 122 x 7 mm
Drill hole \varnothing	7 x 11 mm
Mounting method	Key-hole mounting
Temperature range	-20...+60 °C, no condensation

Commercial data

Net weight	7550
Weight unit	gram
Basic unit	pc.
Customs tariff number	85043180
Unit (piece)	1
Minimum order quantity (piece)	1

All data on this data sheet was compiled carefully.

Liability regarding correctness, completeness, and actuality is limited to gross negligence. Created: 08/13

Circuit diagram

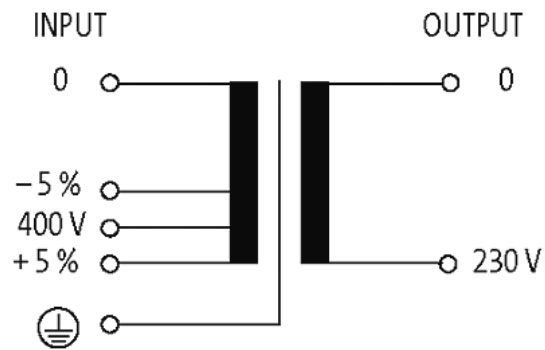

Dimension drawing

