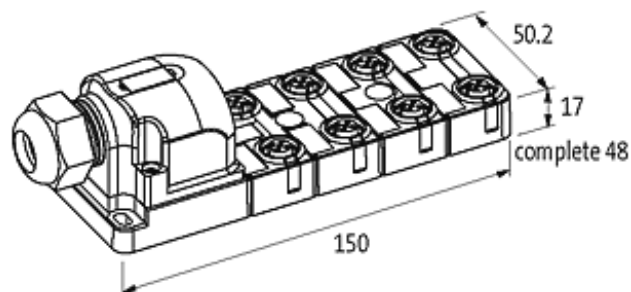

**EXACT12, 8XM12, 5-POLE, CAP, PLUG. SCREW-TERM.**

8-way, 5-pole  
Form PNP  
Screw plug-in terminals

Plastic housings with good resistance against chemicals and oils. The resistance to aggressive media should be individually tested for your application. Further details on request.

[Link to Product](#)**Illustration**

M12-Females 5-pole

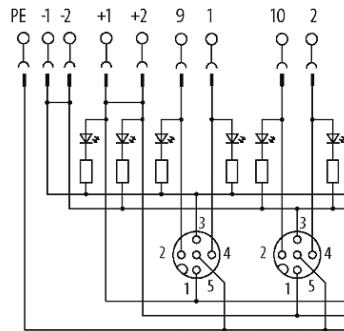
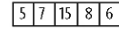
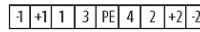
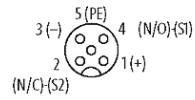
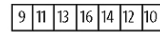

for 2 signals per port

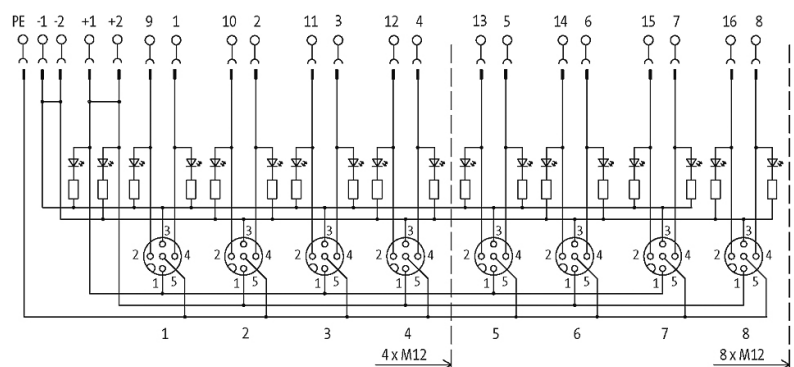
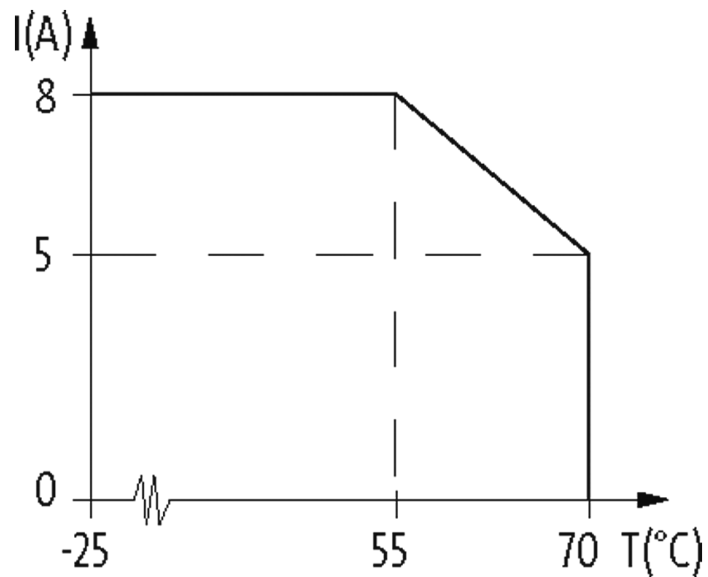

Product may differ from Image

### Approvals



### Contact layout

PIN 1	(+)
PIN 2	(NC)/(S2)
PIN 3	(-)
PIN 4	(NO)/(S1)
PIN 5	(Earth)
LED display	LED (green): Power / LED (yellow): (S1) / LED (white): Signal (S2)

### Technical data

Operating voltage	24 V DC
Operating current per contact	max. 4 A
Total current	max. 8 A
Connection	Screw plug-in terminals: max. 1.5 mm <sup>2</sup> (AWG 16)
Protection	IP65/IP67
Housing	Plastic, flame retardant

### General data

Temperature range	-20...+70 °C
-------------------	--------------

### Commercial data

country of origin	DE
customs tariff number	85369010
EAN	4048879053846
eClass	27143423
Packaging unit	1