

## MEF EMC-FILTER 1-PHASE 2-STAGE

I:6A U:250 VAC/300 VDC snap on

Current: 6 A  
DIN-rail mountable

Attenuation curves on request.

### [Link to Product](#)

#### Illustration

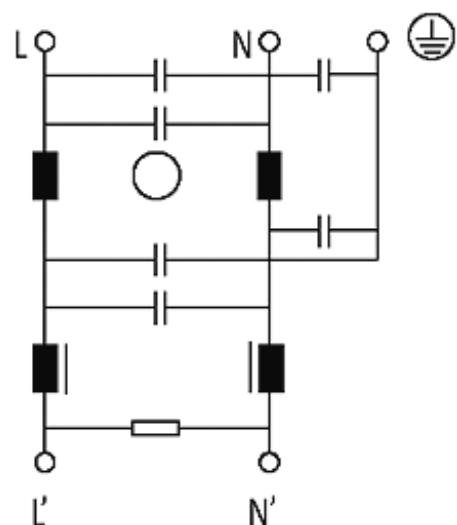

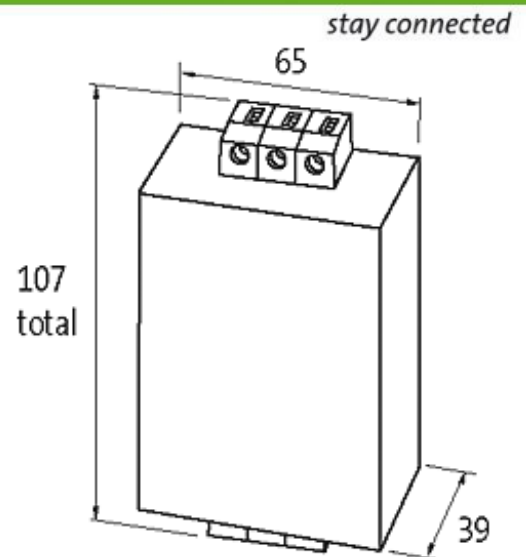

Product may differ from Image

### Approvals



### Technical Data

Operating voltage	max. 250 V AC/300 V DC
Operating frequency	50...60 Hz
Consumption at 250 V AC	max. 5 mA
Overload current	18 × (IN t) max. 0.5 ms; 1.5 × (IN t) max. 1 min. (1 × per hour)
Connection cross section	0.2...6 mm <sup>2</sup> single core (AWG 24...9); 0.2...4 mm <sup>2</sup> multiple core (AWG 24...11)

### General data

Climatic category	25/085/21 (EN 60068-1)
Test isolation voltage	2.7 kV (L - N), 2 s; 2.1 kV (L - L), 2 s (EN 60939-2)
Connection	Screw connection, touch protected
Mounting method	DIN-rail mountable TH35 (EN 60715)
Dimensions H × W × D	107×65×39 mm

### Description

Functional description	The single phase 2-stage EMC filters MEF 1/2 are used in the range 0.1...30 MHz to suppress cable carried interference on mains and control cables. The best filter performance is achieved by using short connection wires (suggestion: earth connection < 10
Application	symmetrical interferences: units with high repetitions of the switching processes, - switch mode P.S.U.s, - phase angle controller, - supply of universal motors, - behind transformers

### Commercial data

country of origin	IT
customs tariff number	85363010

minimum order quantity

1