











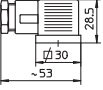
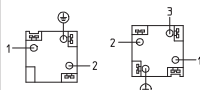

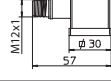

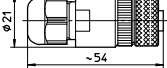

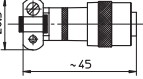





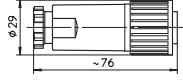





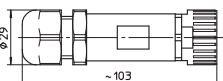

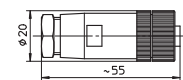

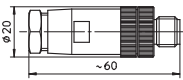



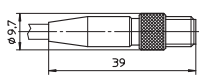

Electric/electronic connectors

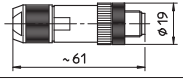
1 ELECTRIC CONNECTORS FOR ON/OFF VALVES

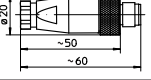
CODE AND DIMENSIONS	APPLICATION	ELECTRICAL TERMINAL VIEW (1)	SOCKET INTERFACE	CABLE GLAND Ø CABLE	REFERENCE RULES
345 	Standard connector S (signal) for position trasducer for ZO(R)-T and ZO-L proportional valves of connector Sensor connector for DH*/FI			PG7 ø 4 ÷ 6 mm	Protection degree IP 65 DIN 40050
664 666 (2) 	Connector for pressure switch type MAP Standard connector for ON/OFF valves, DC or AC power Standard connector (power) for ZO(R)-A, ZO(R)-T, ZO-L proportional valves			PG11 ø 8 ÷ 10 mm	DIN 43650-A/ISO 4400 Protection degree IP 65 DIN 40050
667-24 (-110, -220) 666/M12 	Optional transparent connector for ON/OFF valves with built-in led Optional sensor connector for safety valves			M12x1	DIN 43650-A/ISO 4400 (valve interface) M12x1 (user interface) Protection degree IP 65 DIN 40050
ZH-4P/68 	Sensor connector for ON/OFF safety cartridges type JODL/FI			PG09 ø 6 ÷ 8 mm	M12 IEC 60947-5-2 Protection degree IP 65 DIN 40050
PT-06E-8-3S 	Optional /H connector for intrinsic safety solenoids			ø 3,2 mm	According to MIL-C-26482 Protection degree IP 67 DIN 40050
PT-06E-10-6S 	Standard military connector for joysticks type E-TLP			ø 4,8 mm	According to MIL-C-26482 Protection degree IP 67 DIN 40050

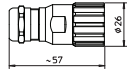









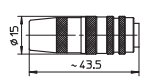

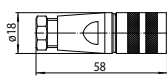
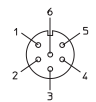

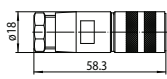
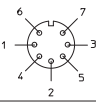

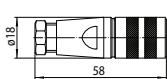
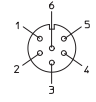

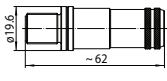
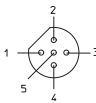
2 ELECTRIC CONNECTORS FOR PROPORTIONAL VALVES

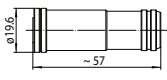
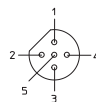
ZH-7P 	Standard single - 7 pins, plastic glass fiber reinforced, connectors for proportional valves with integral electronics			PG11 ø 8 ÷ 10 mm	DIN 43663-BF6-3-PG11 Protection degree IP 67 DIN 40050
ZM-7P 	Metal connector for proportional valves with integral electronics.			PG11 ø 8 ÷ 10 mm	According to MIL-C-5015 G Protection degree IP 67 DIN 40050
ZH-12P 	Connector - 12 pins, plastic glass fiber reinforced, connectors for proportional valves with integral electronics			PG16 ø 6 mm x 2 cable	DIN 43663* Protection degree IP 67 DIN 40050
ZH-5P 	Communication connection for proportional valves with digital integral electronic drivers and CANopen interface Sensor connector for ON/OFF safety cartridges type JODL/FI/T			PG9 ø 6 ÷ 8 mm	M12-IEC60947-5-2 Protection degree IP 67 DIN 40050
ZH-5P/BP 	Communication connection for proportional valves with digital integral electronic drivers with PROFIBUS-DP interface			PG9 ø 6 ÷ 8 mm	M12-IEC60947-5-2 Protection degree IP 67 DIN 40050 Reverse Key
ZBE-06 	Female connector - 4 pins for main stage transducer LIQZO-T*, size 50. For integral pressure transducer of TERS proportional valves and for /FV position switch of safety valves			-	M12 IEC 60947-5-2 Protection degree IP 67 DIN 40050
ZH-4P-M8/5 ZH-4P-M8-2/2 	Pressure transducer connector for digital integral electronics (TES/LES) with options /SL, SP. Cable lenght 5mt Pressure transducer connector for digital integral electronics (TEZ/LEZ) with option /SF. Splitting cable lenght 2,5 mt			Moulded on cable	M8-IEC 60947-5-2 Protection degree IP 67 DIN 40050
ZM-4PM/EH 	Communication connector for proportional valves with digital integral electronic drivers with EtherCAT interface			ø 4 ÷ 8 mm	M12-IEC61076-2-101 Protection degree IP 67 DIN 40050
ZH-5PM 	Connection for proportional valves with digital integral controller, with remote analog transducer (position, pressure, force)			PG7 ø 4 ÷ 6 mm	M12-IEC60947-5-2 Protection degree IP 67 DIN 40050
ZM-12P-M23 	Metallic male connector - 12 pins for digital integral controller whit digital position transducer			ø 3 ÷ 7 mm	-

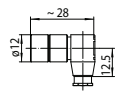
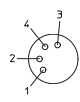

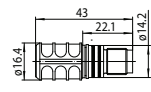
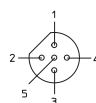

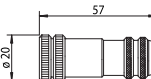
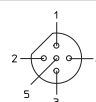
(1) Connection of electrical terminals must be realized according to instructions of the specific technical table of the valve.

(2) These connectors are black. White versions are also available (**666/A, 669/A**)

3 CONNECTORS FOR CK* SERVOCYLINDER

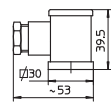
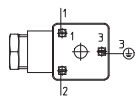
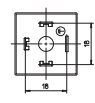
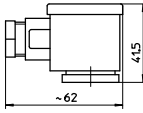
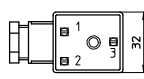
CODE AND DIMENSIONS	APPLICATION	ELECTRICAL TERMINAL VIEW (1)	SOCKET INTERFACE	CABLE GLAND Ø CABLE	REFERENCE RULES
PT-06W-8-4S 	Standard military connector for CKP and CKV servocylinders with position transducer Connector for transducer output			ø 4,2 ÷ 5,8 mm	According to MIL-C-26482 Protection degree IP 67 DIN 40050
ST-CO-9131-D06-PG9 	Female connector - 6 pins for CKM servocylinders with CANopen interface Connector for transducer output			PG09 ø 6 ÷ 8 mm	DIN 45322 Protection degree IP 67 DIN 40050
ST-CO-9131-D07-PG9 	Female connector - 7 pins for CKM servocylinders with digital SSI position transducer Connector for transducer output			PG09 ø 6 ÷ 8 mm	DIN 45329 Protection degree IP 67 DIN 40050
ST-CO-9131-D 	Female connector - 6 pins for KKN and CKM servocylinders with analog position transducer Connector for transducer output			ø 4 ÷ 6 mm	DIN 45322 Protection degree IP 67 DIN 40050
560884 	Male connector - 5 pins for CKM servocylinders with digital position transducer with PROFIBUS DP interface Connector for bus output			ø 6,5 ÷ 8,5 mm	M12 IEC 60947-5-2 Protection degree IP 67 DIN 40050
560885 	Female connector - 5 pins for CKM servocylinders with digital position transducer with PROFIBUS DP interface Connector for bus input			ø 6,5 ÷ 8,5 mm	M12 IEC 60947-5-2 Protection degree IP 67 DIN 40050
560886 	Female connector - 4 pins for CKM servocylinders with digital position transducer with PROFIBUS DP interface Connector for power supply			ø 5 mm	M8 IEC 60947-5-2 Protection degree IP 67 DIN 40050
560888 	Female connector - 5 pins for CKM servocylinders with digital position transducer with PROFIBUS DP interface Connector for bus terminator			-	M12 IEC 60947-5-2 Protection degree IP 67 DIN 40050
CON031 	Female connector - 5 pins for CKF servocylinders and electronic conditioning card of CKN servocylinders Connector for transducer output			ø 6 ÷ 8 mm	Protection degree IP 67 DIN 40050

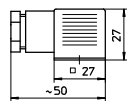
4 ELECTRONIC ACTIVE CONNECTORS FOR ON/OFF VALVES

CODE AND DIMENSIONS	APPLICATION	ELECTRICAL TERMINAL VIEW (1)	SOCKET INTERFACE	CABLE GLAND Ø CABLE	REFERENCE RULES
669 (2) 	Option connector for ON/OFF valves with built-in rectifier bridge for supplying DC coils by AC current			PG11 ø 8 ÷ 10 mm	DIN 43650-A/ISO 4400 Protection degree IP 65 DIN 40050
E-SD/AC 	Electronic connector which eliminate electric disturbances when AC solenoid valves are deenergized Power supply: 110/50, 115/60, 220/50, 230/60 V _{AC}			PG11 ø 8 ÷ 10 mm	DIN 43650 Protection degree IP 65 DIN 40050
E-SD/DC 	Electronic connector which eliminate electric disturbances when DC solenoid valves are deenergized Power supply: 12, 24, 48 V _{DC}			PG11 ø 8 ÷ 10 mm	DIN 43650 Protection degree IP 65 DIN 40050

(1) Connection of electrical terminals must be realized according to instructions of the specific technical tables of the valve.