



DOUBLE-ROW SPHERICAL ROLLER BEARINGS



ULTAGE
CERTIFIED EFFICIENCY

www.ntn-snr.com

With You



Part 1 NTN-SNR ULTAGE. The fundamentals	02
• NTN-SNR BEARINGS. The expertise of a manufacturer, the scope of a leader	04
• ULTAGE double-row spherical roller bearings: the concept of ultimate performance	06
• ULTAGE, your satisfaction first and foremost	08
• The NTN-SNR range of double-row spherical roller bearings	09
Part 2 Characteristics of the ULTAGE range	10
• Research & Development	12
• Cage types	13
• Optimisation of load capacities	15
• Reduced friction	15
• Optimisation of operating speeds	15
• Optimisation of steels	16
• Heat treatment and temperatures	16
• Controlled manufacturing	17
• Optimised design for better lubrication	17
• Quality: a shared vision	17
Part 3 ULTAGE: performance for your applications	18
• Your requirements determine our solutions	20
• NTN-SNR ULTAGE for high-vibration applications: EF800 series	22
• NTN-SNR ULTAGE for harsh environments: EE sealed series	25
• Solid lubrication or lifelong lubrication	27
• Low-noise bearings	28
• Special treatment for hard-to-lubricate applications or polluted lubrication	28
• Bearings with reinforced steel cages	29
Part 4 Technical recommendations	30
• Nominal service life	32
• Adjusted nominal service life	33
• Method for determining a_{iso} (ISO 281 standard)	34
• Speeds	36
• Lubrication	39
• Mounting and removal	44
Part 5 Technical data for bearings	50
• General information	52
• Designation of bearings: prefixes, suffixes	55
• List of double-row spherical roller bearings	56
• List of adapter sleeves and withdrawal sleeves	72
Part 6 Housings for spherical roller bearings	76
Part 7 Experts & Tools services	80
• Mounting and dismounting tools	82
• Lub'solutions	83
• Services	84

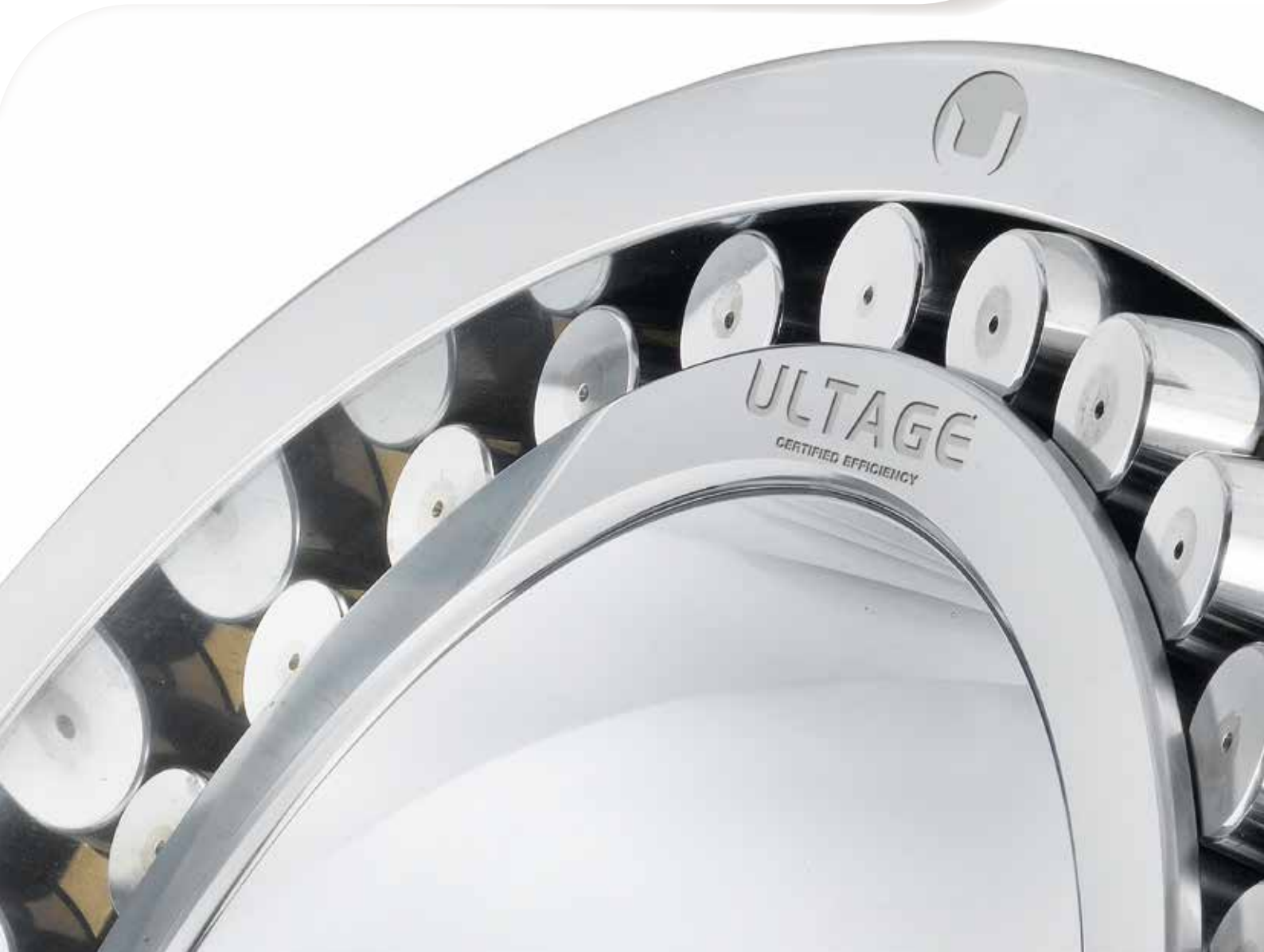



Part 1

NTN-SNR ULTAGE. The fundamentals

- NTN-SNR BEARINGS. The expertise of a manufacturer, the scope of a leader 04
- ULTAGE double-row spherical roller bearings: the concept of ultimate performance 06
- ULTAGE, your satisfaction first and foremost 08
- The NTN-SNR range of double-row spherical roller bearings 09

NTN-SNR ROULEMENTS

The expertise of a manufacturer, the scope of a leader

The European Arm of NTN Corporation, the world's 3rd largest bearings group, NTN-SNR BEARINGS specialises in the design, development and manufacture of high-performance rotation and guidance systems. A major player and a recognised supplier to some of the leading names in industry, the company takes pride in following through with its initial commitment: to put the best technology to the service of your applications.



An offering that is developed with and for you

With a ubiquitous presence in the industrial, automotive and aerospace markets, NTN-SNR is not merely content to propose the most comprehensive range available on the market, both for first-fit and for spares, from the standard range to the specialist solution. Driven by a well-honed sense of innovation and a constant concern for quality, we strive daily to enhance the performance of our bearings and anticipate your future requirements.

More compact, lighter, more economical, more reliable, more efficient and more eco-friendly, our products are invested with all the ingenuity that went into their design and all the care that guided their manufacturing. In order to take account of all your requirements, from the most common to the most specific, and to satisfy your economic and ecological objectives.

A worldwide presence, and close at hand

With 100 or so sites around the world, all subject to the same degrees of excellence, we have teams on hand everywhere, ready to come to your aid, guaranteeing consistent quality of our products and services. In close attendance to you and your needs, trained to deal with your priorities, and familiar with your business, they concentrate on developing products and solutions that take account of all your constraints and

requirements. Working at your side, our teams use their talents in the service of your particular objectives, and commit themselves to ensuring your satisfaction.

Innovation as a founding value

- With over 5% of our revenue invested annually in Research & Development...
- an R&D division with a headcount of over 400, all of whom every day, are exploring and investigating every domain
- a technical centre with a wealth of laboratories
- a mechatronics development centre
- a test centre with over 200 test benches

... innovation and progress are no simple declarations of intent, but priorities applied daily in our workshops in order to come up with the bearing that will meet your future needs.



The environment as a priority issue

Protecting the environment is a major and universal challenge for our company. This basic principal is applicable at every stage of our activities and is nurtured by every one of our employees.

On the **product side**, our commitment is to help reduce your energy bill and your carbon footprint:

- through specific work carried out on eco-bearings, requiring even less energy consumption. The objective: to reduce friction torque in order to rotate more easily, thus reducing CO2 emissions and energy consumption.
- through developing solutions for clients who are strongly committed to renewable energies such as wind and solar power.

On the **production side**, we are continually improving our industrial processes:

- Developing production sites in order to reduce their consumption of energy, water and chemical products
- Pursuing a policy of waste and atmospheric pollutant emissions management

... In all our plants, each one ISO 14001-certified, nothing is left to chance.



ULTAGE double-row spherical roller bearings

The concept of ultimate performance

PREMIER, the previous generation of double-row spherical roller bearings, used and appreciated the world over, has amply demonstrated its high performance, technical quality and long service life... The latest generation of premium bearings, the ULTAGE range, now offers you even more when it comes to performance.



Born of the association of two concepts («ULTIMATE» and «STAGE»), the ULTAGE label marks out our standardised range of Spherical Roller bearings as offering you optimised performance as standard: longer service life, faster rotation speeds, reduced usage costs and an improved contribution to environmental protection.

Performance at all levels

To meet your expectations, a great deal of research work has been carried out on the intrinsic components of ULTAGE bearings. These include:

- selecting better quality steel
- applying heat treatment to endow the bearings with exceptional properties.
- a new internal bearing design: increased load capacity, increased speeds, cages reinforced by specific surface treatment.
- developments with regard to seal technology, etc. At all levels, quality remains the byword, enabling your machinery to achieve its optimum performance.

Tilt capability

NTN-SNR ULTAGE double-row spherical roller bearings consist of:

- an outer ring with spherical raceway,
- two symmetrical rows of spherical rollers held in cages,
- an inner ring with a cylindrical or tapered bore

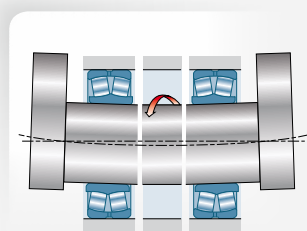

The rollers move freely in the spherical raceway of the outer ring. This allows the bending of the shaft and alignment faults on the bearing seats to be compensated for.

Very high load capacities

The internal design of double-row spherical roller bearings enables them to withstand very high radial loads and axial loads in both directions.

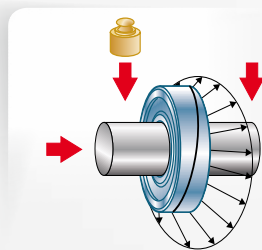

NTN-SNR ULTAGE spherical roller bearings are designed without any central shoulder section or floating guide ring, for supporting the heaviest of loads thanks to a maximum number of long, large-diameter rollers. In association with the high-performance materials, optimised surfaces and surface-treated cages, the precise osculation ratios between the rolling elements and the raceways that uniformly distribute the stresses in the bearing enable significant improvements to be made to the service life expectancy

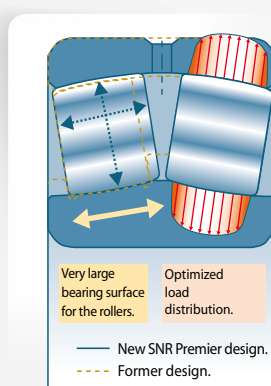

Ultimately, these optimised specifications of NTN-SNR ULTAGE double-row spherical roller bearings make it possible to design machines that are more compact and more reliable.

NTN SNR “Premium Quality” spherical roller bearings

You are already familiar with generation E:

- Optimised design
- No central rib (except series 240xx and 241xx)
- More, larger, longer rollers
- New cages
- Increased load capacities

Now you can benefit from all the benefits of the ULTAGE generation:

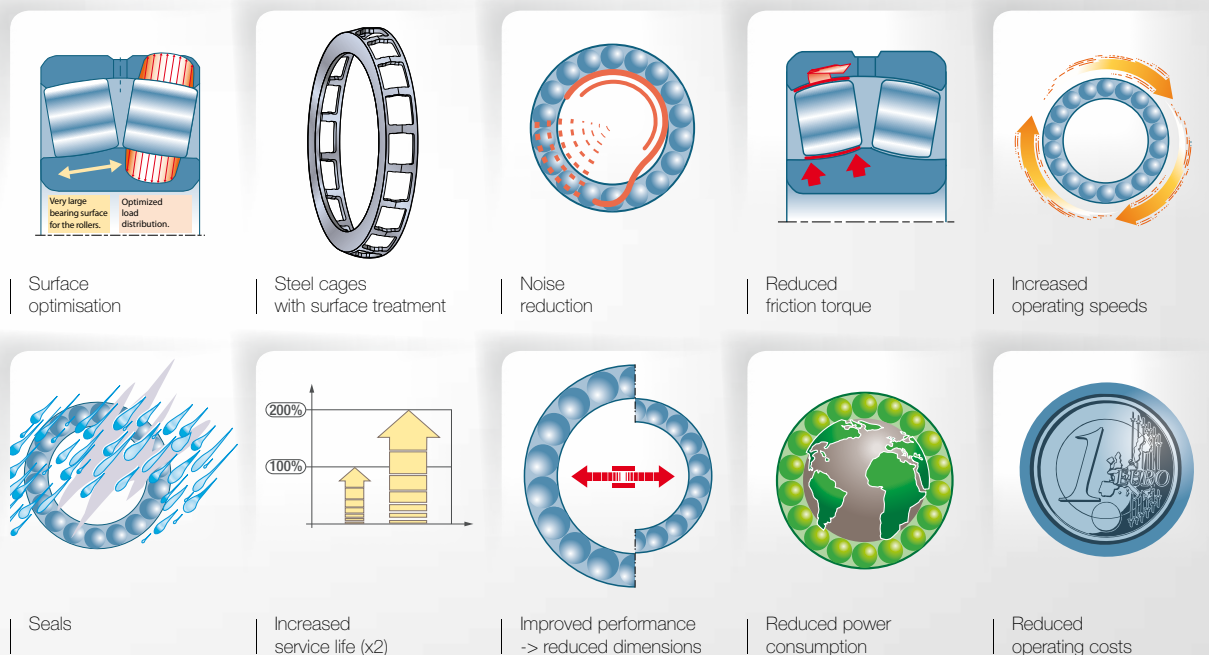

Designed for applications in extremely harsh operating environments (steelworks, paper mills, wind farms, mines and quarries, etc.), double-row spherical roller bearings need to be able to withstand:

- high loads and temperatures
- major misalignments
- polluted atmospheres
- impacts, vibrations.

All these conditions call for exceptional mechanical qualities.

The NTN-SNR engineers and scientists therefore work tirelessly on:

- materials selection, heat treatments, surface treatments
- product design
- the kinematics of bearings when combining the effects of lubrication with reduced friction, wear & tear and pollution
- manufacturing technologies and the improvement of the manufacturing processes.

All this effort generates spectacular results.

Thanks to their dynamic load capacities, among the highest on the market, and the optimisation of all constituent parts of the bearing, NTN-SNR ULTAGE double-row spherical roller bearings allow you to benefit from PREMIUM performance:

- double the service life compared to a standard solution
- improved reliability for your installations
- reduced costs of use.

ULTAGE, your satisfaction first and foremost

Greater load capacity for your applications

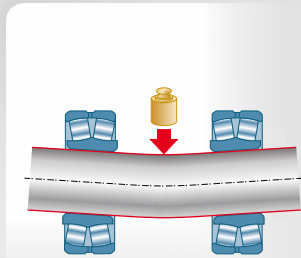

With their optimised internal geometry and surfaces, produced using high-performance materials and with a maximum number of long, large-diameter rolling elements, NTN-SNR ULTAGE double-row spherical roller bearings guarantee you:

- the best load capacity levels on the market,
- increased operating times.

Among the benefits deriving directly from this:

- longer intervals between maintenance operations,
- size reduction with the possibility, under like-for-like operating conditions, and as standard, of using a technical solution with smaller bearings.

Optimised ROI from your Machines



The optimised internal design offers higher speeds thanks to reduced friction.

As a result, the service life of your machines is extended and the operating temperatures are kept lower.

For you this means:

- better returns from your machine pool
- lower maintenance costs
- reduced power consumption
- reduced lubricant consumption

A solution in compliance with the new environmental challenges



Reduced maintenance costs, less noise, less friction, reduced power consumption, reduced lubricant consumption for the sealed versions and longer service life: the use of NTN-SNR ULTAGE double-row spherical roller bearings is synonymous with:

- less impact on the environment
- less power consumption

Your satisfaction: our priority at all times



- «Premium» performance
- Reduced Cost, Reduced Maintenance
- Reduced environmental impact...

These are powerful and distinctive assets marking out the ULTAGE range, offering major benefits to guarantee your satisfaction.

Easy to identify

The NTN-SNR ULTAGE bearings keep the same standard designations (e.g., 22209EAW33).

To make it easier to identify your high-performance bearings, each bearing and its box are endorsed with the ULTAGE logo.

The NTN-SNR range of double-row spherical roller bearings

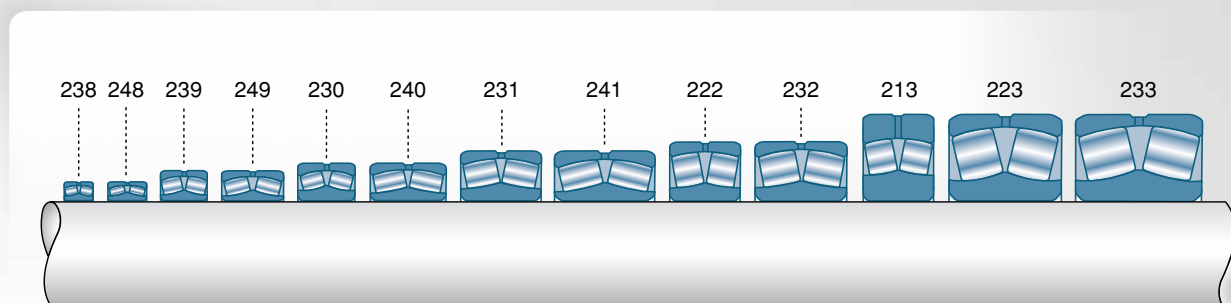

Description

NTN-SNR proposes a full range of double-row spherical roller bearings with bores from 25 to 1800 mm, available with cylindrical or tapered bore. Most tapered bore bearings require the use of an adapter or withdrawal sleeve for mounting on the shaft.

Most bearings are equipped with a groove and lubrication holes in the outer ring. Bearings with metal cages can operate at temperatures of up to +200°C. The dimensional stability of the steel is guaranteed by means of specific heat treatment. These bearings are available in a wide range of series designed to cater to the broadest spectrum of usages depending on your requirements in terms of loads, speeds and dimensions.



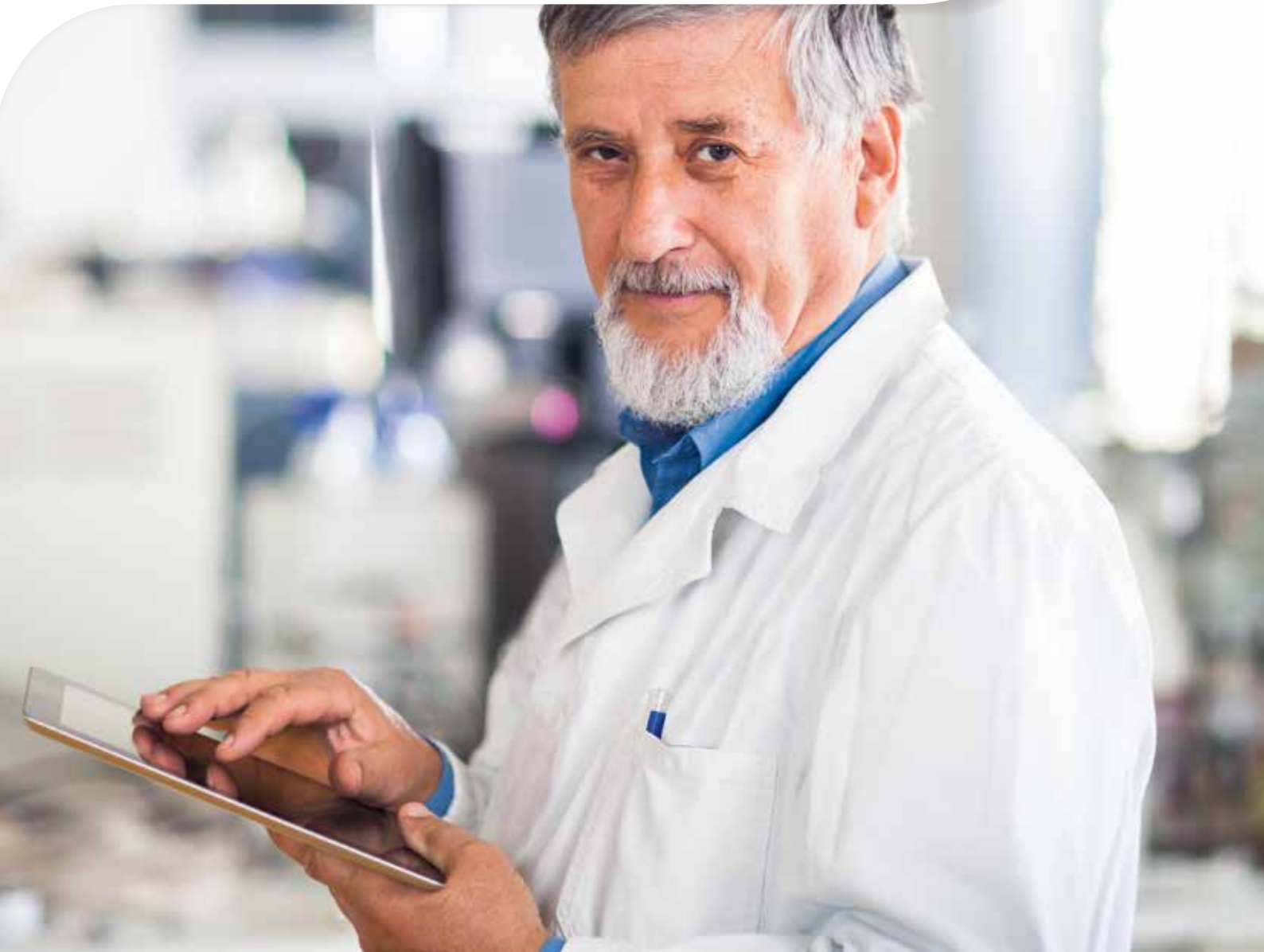



Part 2

Characteristics of the ULTAGE range

• Research & Development	12
• Cage types	13
• Optimisation of load capacities	15
• Reduced friction	15
• Optimisation of operating speeds	15
• Optimisation of steels	16
• Heat treatment and temperatures	16
• Controlled manufacturing	17
• Optimised design for better lubrication	17
• Quality: a shared vision	17

Reminder: BASIC DESIGN

NTN-SNR ULTAGE RANGE, type E design:

- Symmetrical rollers
- No central rib for optimal load capacity and optimum lubricant flow in the bearing.
- Stabilisation of steels for use at temperatures of up to +200°C
- Optimised internal geometry to minimise friction and heat build-up
- Steel plate cage for standard usages
- Machined brass cage for the harshest of operating conditions
- Fiber glass-reinforced polyamide cage for applications at temperatures of up to +150°C.

NTN RANGE, type B design:

- Asymmetrical rollers
- Shoulder section fixed to the centre of the inner ring
- Stabilisation of steels for use at temperatures of up to +200°C
- Steel plate cage for standard usages
- Machined brass or steel cage for harsh applications

Research & Development



On account of all the parameters within a bearing interacting with one another, it is therefore vital to work on every aspect: the steels, the heat treatment, the geometry of the bearing components, the lubrication, the friction, and so on, in order to achieve the best technical solution.

Exploring and testing out the possibilities in the field of fundamental or applied research is the mission entrusted to our European R&D centre: a unique centre with several hundred people working on preparing the bearings of the future, with the support of many labs (computation and simulation, materials lab), a mechatronics development centre and a test centre with over 200 test benches.

Day-in, day-out:

- Materials development,
 - Surface heat treatments,
 - Means of manufacturing and computational software,
- are all fields of study for our engineers and scientists, all with one and the same objective in mind: to provide you with more compact, more lightweight, more economical, more reliable, better performing and more ecological products.

More than ever, NTN-SNR is committed to marshalling its efforts to guarantee your satisfaction.

Cage types

Standard applications • ULTAGE EA design

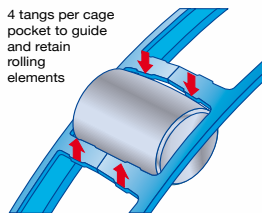
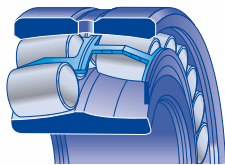

Characteristics and benefits

- Symmetrical rollers with two steel plate window cages centred on the ground surface of the inner ring.
- Precise guidance of the rollers with a unique concept for perfect control of the position of the rolling elements without the need to use a floating guide ring or fixed central shoulder section.

This concept keeps friction and heat build-up to a minimum in order to guarantee longer service life and reduced maintenance costs.

- Cages protected against wear & tear by means of surface hardening and a phosphatizing coating.
- Reduced friction coefficient for better operation at high speeds.
- The versions with window-type cages in surface-hardened steel plate offer you reinforced resistance characteristics.

Harsh application environments • ULTAGE EM design

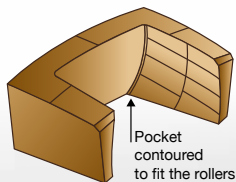
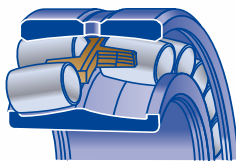

Characteristics and benefits

- Symmetrical rollers with a machined brass alloy one-piece cage centred on the rolling elements.
- No floating guide ring or fixed central shoulder section. This prevents any risk of cage/ring seizure in the event of thermal expansion. The self-lubricating properties of the cage material reduce heat build-up at high speeds.
- The contoured profile of the cage pockets, combined with the capacity of the copper alloy to withstand impacts, guarantees the stability of the rolling elements under the harshest of operating conditions.

This type of cage is particularly suited to increase the bearing life duration in the most demanding of applications, as may be encountered in the steel industry, the paper industry, mines and quarries, etc.

High-vibration applications • ULTAGE EF800 design

Machined solid cage
Tolerances interval

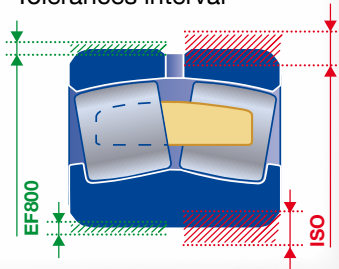

Characteristics and benefits

- Symmetrical rollers with a machined brass alloy one-piece cage centred on the rolling elements.
- No floating guide ring or fixed central shoulder section. This concept prevents any risk of cage/ring seizure in the event of thermal expansion.
- Bearings manufactured according to specification EF800 which sets out the special tolerances and radial clearance of double-row spherical roller bearings.
- Reduced bore and outer diameter tolerances, radial clearance tolerances reduced to 2/3 of the clearance value concerned. These provisions guarantee control of the final radial clearance following assembly and allow the specific conditions to which vibrating machinery are subject to be taken into account.

This concept increases the service life, decreases maintenance time, and increases the reliability of production.

Harsh environments – ULTAGE EE design

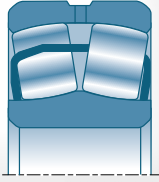

ULTAGE EA
Conception open

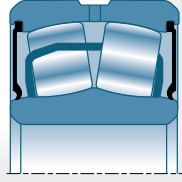

ULTAGE EA
Conception sealed

Characteristics and benefits

- Design characteristics similar to those of the ULTAGE EA design.
- Nitrile lip seals.
- Withstands misalignments with no service life reduction.
- Compact design. Depending on the series, the width may be slightly greater than on the open variants.
- Lubricated with special high-pressure grease.

EE bearings reduce the risks of exposure to contamination in harsh environments, enabling longer intervals between maintenance and keeping lubricant consumption to a minimum.

General applications ($T^{\circ} < 150^{\circ}C$) - ULTAGE EG15 design

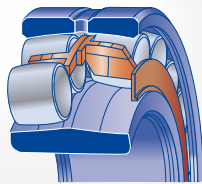

Contoured profile for a close guidance of rolling elements

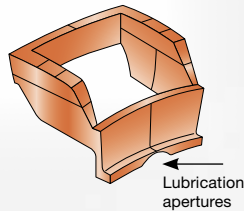

Lubrication apertures

Characteristics and benefits

- Symmetrical rollers with a polyamide 6.6 cage reinforced with 25% glass fibre.
- Flexibility and elasticity of the material, contoured profile of the cage for close guidance of the rolling elements, low friction coefficient, optimised distribution of lubricant.

This concept is perfectly suited to general applications where the temperature does not exceed $+150^{\circ}C$.

New patented cage for the 240xx and 241xx series

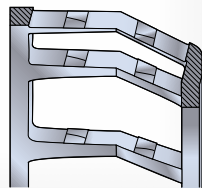

Standard cage

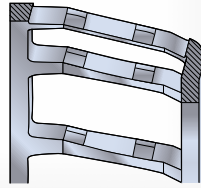

New profile for 240xx and 241xx series

NTN-SNR works constantly on improving its product ranges. A new patented cage design has therefore been developed for the 240xx and 241xx series. These two series are characterised by a very large ring diameter, and consequently longer rollers than for the other series.

The elimination of the central rib, in order to obtain higher load capacities, requires high-precision guidance of the rolling elements:

- by optimising the curve radii of the rings,
- by creating a specific cage suited to the configuration of these bearings.

The EA type cage profile for the 240xx and 241xx series is particularly suited to the long rollers used in these series. The guidance of the rolling elements has been improved and their natural pivoting during operation is better controlled. This double-sloped profile makes it possible to position the guide tabs of the cage parallel to the axis of the rolling elements. The contact surfaces are therefore better balanced and the clearance of the rolling element in the pocket is better controlled.

This leads to less wear and tear, reduced friction and a longer service life for the bearing.

Optimisation of load capacities

The optimised osculations of the double-row spherical roller bearings of the ULTAGE series and the symmetrical rollers enable optimum load distribution along the roller contact line. ULTAGE bearings offer maximum load capacities to support all load configurations.

Reduced friction

The definition of the osculations of the ULTAGE double-row spherical roller bearings allows the rollers to be guided exclusively by the raceways and the cage, and to eliminate the use of a guide ring.

The number of components in the bearing is reduced and friction kept to a minimum.

Heat build-up is reduced, with the resultant optimisation of lubricant and power consumption and lower operating costs.

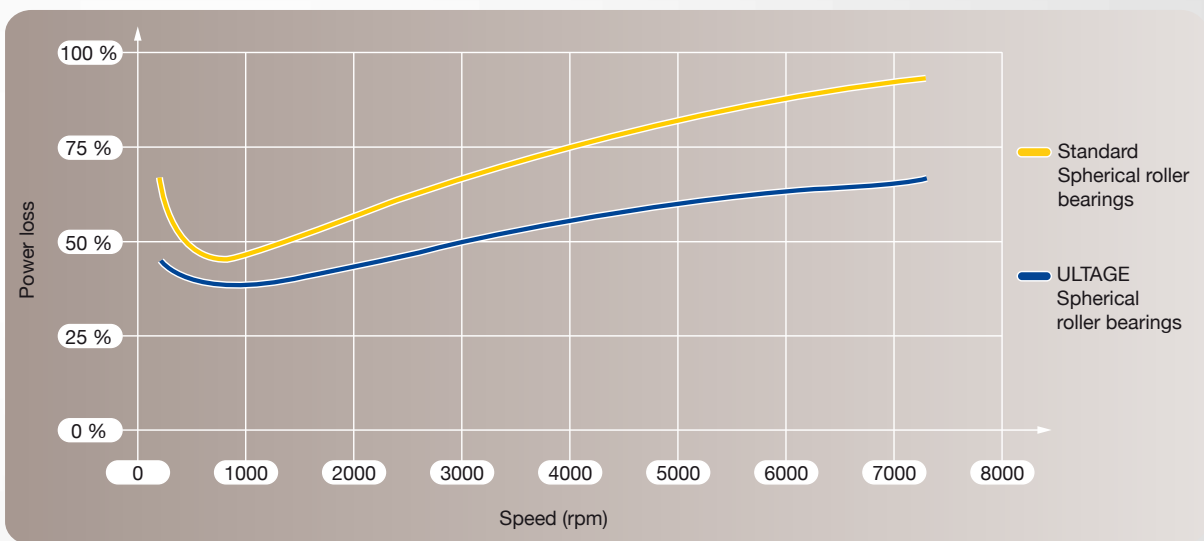

Reduced power dissipation vs speed.

Optimisation of operating speeds

In general, the operating speed limit of a bearing is determined by the permissible temperature, taking into account the lubricant and the rollers.

To take account of these parameters, the new speeds for the double-row spherical roller bearings of the NTN-SNR ULTAGE range, as stated in the product tables, are the thermal reference speed and the limiting speed.

Thermal reference speed n_{gr} : speed at which the bearing temperature reaches +70°C under the reference conditions. These values are in compliance with standard ISO 15312.

Limiting speed: maximum permissible speed which depends on the mechanical limits, such as the tensile strength of the constituent components of the bearing.

Thermally safe operating speed: the rotational speed at which the average temperature of the bearing reaches the permissible limiting value under actual operating conditions. This takes account of the influence of the oil viscosity and the load at the reference speed.

To determine the permissible speed of your bearing, refer to page 38- 39

Optimisation of steels

NTN-SNR has always placed an emphasis on the choice of raw materials used in manufacturing its bearings.

Thanks to our strong relationship with the manufacturers of special steels, we have acquired an excellent understanding of the steelmaking process. We have developed a certification process based on two pillars:

- **Technical audit**, carried out on the basis of a guide that covers point by point all the stages of steelmaking processes dedicated to high-purity steels, in order to assess and select the best steel suppliers.
- **FB2 contact fatigue test developed by NTN-SNR**, for testing the bearing steel under set conditions, which are reproducible and representative of severe operating conditions. These conditions mean that the testing is extremely sensitive to the inclusionary cleanliness of the steel. It is therefore possible to test a volume of material 100 times greater than can be achieved using traditional microscopic inclusion ratings as defined by the standards ISO 4967, DIN 50602, ASTM E45 and so on.

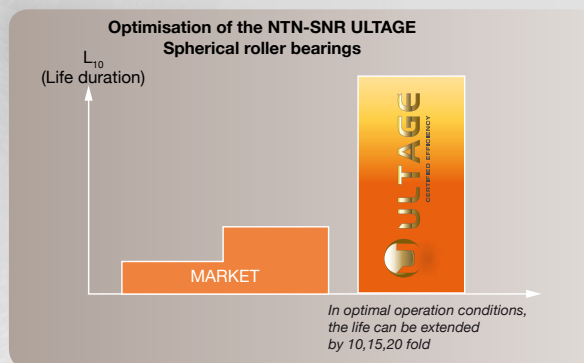

The results of this testing lead to the best steels being selected in the manufacturing of our double-row spherical roller bearings. These high-performance NTN-SNR steels, with their extremely high inclusionary cleanliness, make it possible to obtain higher load capacities for our bearings and a longer service life under the most demanding operating conditions.

Heat treatment and temperatures

Martensitic hardening as traditionally applied to bearing components produces a hard, resistant structure but one that is highly-stressed and fragile, containing an unstable phase: the residual austenite.

The tempering carried out after hardening on the NTN-SNR ULTAGE double-row spherical roller bearings is intended:

- to increase its toughness for improved resistance to impact while maintaining a high degree of hardness (approximately 62Hrc),
- to guarantee resistance to wear and tear and durability at a level compatible with the various applications for which it is intended.

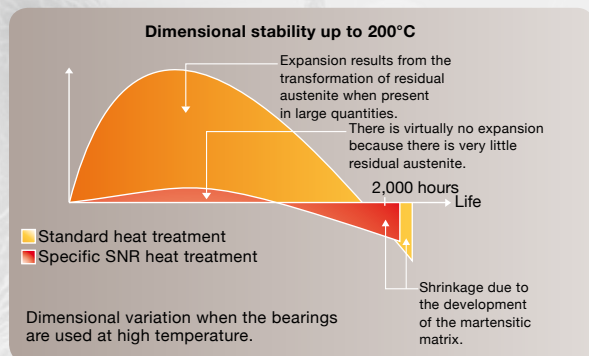

This particular treatment also makes it possible to obtain a dimensionally stable structure by reducing the residual austenite content to a very low level in order to guarantee usage at temperatures of up to +200°C.

Since the changes that are produced on the atomic scale during the heat treatment operations are invisible, the process must be closely controlled by carefully monitoring the temperature and treatment time parameters. This is why reliable measurement of these parameters has been deployed in the heat treatment installations, so as to guarantee not only the characteristics intended for the product, but also manufacturing consistency.

Controlled manufacturing

NTN-SNR has developed a high-performance quality assurance system for production, underpinned by self-inspection and continuous monitoring of our processes. This system assures the optimal quality of our products over time through controlling every component of the process (means, methods, manpower, environment and materials).

Thanks to the continuous improvement approach applied to its production facilities, and its quality assurance system, NTN-SNR is able to guarantee bearings with ever more precise surfaces for enhanced performance, reduced friction during operation and, consequently, improved lubrication efficiency.

For several years, NTN-SNR has integrated an environmental approach into its manufacturing processes, its product development, its purchasing and its waste treatment.

In line with the conviction that active environmental commitment is key to sustainability, NTN-SNR bearings are no exception to this rule.

Accordingly, numerous initiatives have been undertaken on our production sites:

- controlled use of the water used for cooling the production units
- recycling of cutting oils
- continuous monitoring of CO2 emissions from the boilers in the thermal power plants

Optimised design for better lubrication

Lubrication is an essential factor in the correct operation of a bearing. Indeed, 55% of faults are due to lubrication defects. This concerns its viscosity, but also the way in which the lubricant is distributed between the various elements, as a function of the geometry and condition of the surfaces.

This factor has been particularly optimised for the NTN-SNR ULTAGE double-row spherical roller bearings.

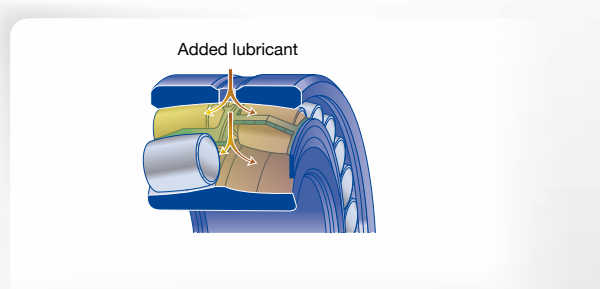

Optimised design for better lubrication

- No central shoulder section. This means that we have a sufficient volume to correctly lubricate the bearing and ensure that the lubricant flow guarantees a permanent lubricant film between rollers and raceways, thereby significantly reducing heat build-up.

- Grooves and lubrication holes: enlarged lubrication groove and increased diameter of the lubrication holes in the outer ring, to facilitate re-lubrication.

- Definition and materials of the cages:
 - Steel plate cage with phosphatising-oiling treatment for lubricant retention.
 - Solid brass cage with self-lubricating properties for reduced friction at high speeds.
 - Fibreglass-reinforced polyamide cage with apertures in the external shroud to facilitate lubrication. Lubrication is also facilitated by the polyamide - steel contact for the rollers and by the material used that is highly resistant to any lubrication defects or deficiencies.

Lubrication tips

It is vital that satisfactory lubrication is obtained as soon as the bearings start to rotate. In the case of lubrication using grease, the grease needs to occupy the entire available volume and, in particular, the space between the cage and the inner ring.

For further information about lubrication tips and NTN-SNR products, please turn to page 40 of this catalogue.

Quality: a shared vision

Our point of reference is quality from the point of view of the customer; in other words, taking account of customer expectations and requirements.

NTN-SNR is committed to the quality of its products on all its production sites. All our bearings comply strictly with the most rigorous of technical requirements.

The quality process is closely controlled at each stage:

- Quality of design
- Quality of product development
- Quality of production
- Quality of marketing
- Quality of services

So that you can be sure of the authenticity of our products, we have developed a label featuring a hologram that is easily identifiable by customers and difficult to fake. These various security levels provide you, the customer, with the guarantee of possessing a 100% NTN-SNR product in compliance with our high technical standards.

Together, let us fight the counterfitters.





Part 3

ULTAGE: performance for your applications

• Your requirements determine our solutions	20
• NTN-SNR ULTAGE for high-vibration applications: EF800 series	22
• NTN-SNR ULTAGE for harsh environments: EE sealed series	25
• Solid lubrication or lifelong lubrication	27
• Low-noise bearings	28
• Special treatment for hard-to-lubricate applications or polluted lubrication	28
• Bearings with reinforced steel cages	29



Your requirements determine our solutions

Because no two applications are identical, NTN-SNR develops solutions suited to your specific conditions, in order to satisfy your requirements to a tee. Equipped with the latest technological advances, our bearings help to make your processes more efficient and more profitable.

NTN-SNR ULTAGE bearings offer:

- **more compact design**
- **high-performance seals**
- **longer service life**
- **reduced energy consumption and less lubricant**
- **reduced vibration levels**
- **reduced, simplified or zero maintenance operations**

Paper industry



The papermaking environment is particularly harsh for bearings:

- Presence of water and water vapour, with the risk of corrosion
- High loads and speeds
- Need for precision rotation
- High temperatures
- Aggressive chemical products (in particular during bleaching)
- High dust levels
- Criticality of precise and reliable lubrication at each point

ULTAGE double-row spherical roller bearings are your ideal technical solution. Equipped with their seals, they offer excellent protection against external pollution, thereby contributing to operational reliability and extended service life.

Mines, quarries and cement works



In the sector that incorporates mining, the processing of ore and the cement industry, bearings operate in an environment that is mechanically very testing:

- Combined loads
- Pollution
- Impacts, imbalances and vibrations
- High temperatures (+100°C)
- High rotation speeds
- Alignment faults

The double-row spherical roller bearings of the EF800 series have been specifically designed to withstand extreme conditions of vibrations, impacts and imbalances. NTN-SNR continues to make a solid contribution to improving machine reliability, security and environmental protection.

Steel industry



The conditions that bearings have to endure are variable, depending on the stage of a given process, but are always very demanding:

- High temperatures leading to expansion and alignment faults
- Very high pressures / heavy loads
- High levels of pollution
- Humidity, steam
- Vibrations, impacts

The double-row spherical roller bearings are perfectly suited to these demanding conditions, through associating the choice of steels of extreme purity with good stability at high temperatures, high load capacities, and resistance to wear and tear.

Transmissions



Reducers and transmission lines are key elements for all types of industries. This applies for all types of industrial processes, such as mining or the cement industry, the steel industry, dockside cranes and movable bridges.

As a manufacturer, you want to increase the performance of your speed reducers as well as minimising your own overheads and those of your customers. Our objective is to work with you in order to reduce the torque or the size, double the service life and improve the energy yield.

Wind farming



In the wind power sector, reliability allied with simplicity of assembly and maintenance, along with ROI, are some of the main requirements of customers. Indeed, the guarantee of profitable wind power production necessitates the reliable, efficient operation of the chosen solutions.

NTN-SNR therefore works with the designers of wind turbines and transmission mechanisms in order to develop the products that meet the requirements of the industry. **In this context, double-row spherical roller bearings offer the ideal response in terms of performance, reliability, reduced maintenance costs, and so on.**

For high-vibration applications: EF800 series

The vibratory mechanisms such as those found in shaker screens, crushers, grinders or construction equipment constitute some of the most demanding applications for bearings. NTN-SNR has therefore developed a range of double-row spherical roller bearings specifically designed to meet these critical requirements.

These bearings are:

- available in the 223xx series with a cylindrical or tapered bore,
- available with bore diameters of between 40mm and 170mm,
- available on request for the other series and bore dimensions.
- manufactured according to specification EF800 which sets out the special tolerances and radial clearance of double-row spherical roller bearings.

Requirements for your high-vibration applications

High vibration machinery (shaker screens, crushers, grinders, etc.) subject bearings to high levels of stress: heavy loads, radial acceleration, centrifugal forces, a highly polluted environment, etc.

All this imposes specific resistance characteristics on the double-row spherical roller bearings.

The high radial accelerations of these applications place a particular strain on the cage. The EF800 series, equipped with solid cages with a contoured profile around the cage pockets, guarantees the stability of the rolling elements in order to limit heat build-up. The capacity of the copper alloy to resist impacts makes the unit capable of withstanding the most testing of operating conditions.



Specific internal design, EF800 series

The absence of a central shoulder section on the inner ring enables maximum load capacity which in turn allows the EF800 series bearings to withstand the extreme wear stresses generated by high-vibration applications.

The lateral shoulders enable axial accelerations to be withstood in extreme cases and are subject to a specific surface treatment. The centred cage, on the rolling elements, eliminates all risk of seizure between the cage and the bearing rings in the event of thermal expansion due to the particular operating conditions of shaker screens.

The many tests carried out on the NTN-SNR test benches have demonstrated the excellent behaviour of our bearings when subjected to intense vibratory conditions.

Comparative test result of EA vs EF800 cage

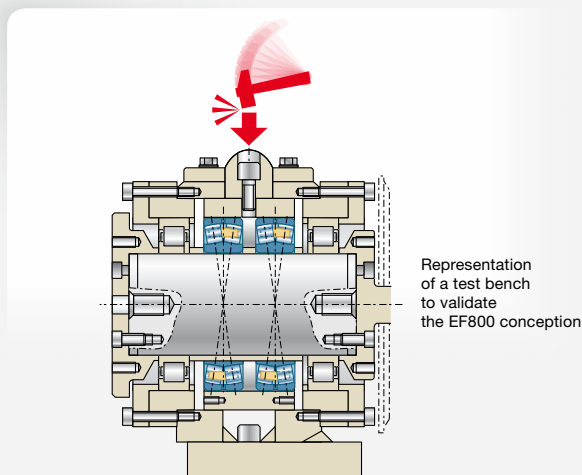
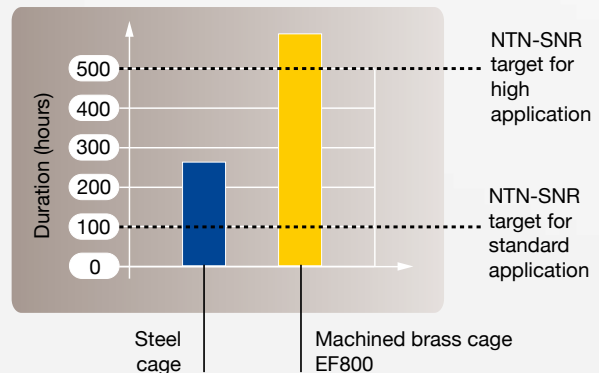

Tolerances

Characteristics of the EF800 series

The EF800 specification sets out reduced bore tolerances for the cylindrical bores, for the tapered bores, for the outer diameters and for the radial clearance, compared to the tolerance ranges of the normal series. See table below.

- Cylindrical bore:** reduced tolerances defined by the EF800 specification guaranteeing a slide fit of the ring over a shaft produced with type g6 or f6 tolerance.
- Tapered bore:** reduced tolerances enabling limitation of the axial displacement of the inner ring when setting the clearance during assembly, thereby facilitating the assembly operations.
- Outer diameter:** tolerances of the EF800 specification guaranteeing the fixed setting of the outer ring in its housing for a type P6 fit.

Internal radial clearances

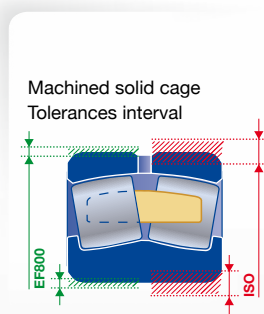

For vibratory applications, the generally recommended clearance is C4. In order to avoid any risk of preload on the bearings, linked to adjustment defects or deformation of the shaft or housing seating surfaces. NTN-SNR proposes a special radial clearance range in the C4 group, reduced to 2/3 greater than the tolerance.

This clearance range facilitates the achievement and control of the final radial clearance after assembly and takes account of the specific operating conditions for these materials.

In certain cases, applications may necessitate the use of a clearance other than group C4. Upon request, we can deliver bearings in groups C3, EF801 series or C0, EF802 series. For the EF801 and EF802 series, and for the EF800 series, the clearance range is reduced to 2/3 greater than the tolerance.

Normal series & EF800 series Comparison of clearance tolerances

Inner ring	Dimensions in mm.					
	Nominal bore	Greater than	30	50	80	120
	Up to	50	80	120	180	250

Micron-scale differences

Cylindrical bore (d)	Normal series	0	0	0	0	0
		-12	-15	-20	-25	-30
EF800 series	0	0	0	0	0	
	-7	-9	-12	-15	-18	
Tapered bore (d)	Normal series	39	46	54	63	72
		0	0	0	0	0
	EF800 series	25	30	35	40	46
		0	0	0	0	0

Outer ring	Dimensions en mm.								
	Nominal outside diameter	Greater than	80	120	150	180	250	315	400
	Up to	120	150	180	250	315	400	500	630

Micron-scale differences

Outside diameter	Normal series	0	0	0	0	0	0	0	0
		-15	-18	-25	-30	-35	-40	-45	-50
		EF800 series	-5	-5	-5	-10	-10	-13	-13
-13	-13		-18	-23	-23	-28	-30	-35	

Normal series & EF800, EF801, EF802 SERIES

Comparison of clearance tolerances • Cylindrical bore

		Dimensions in mm.													
Nominal bore	Greater than	30	40	50	65	80	100	120	140	160	180	200	225	250	
	Up to	40	50	65	80	100	120	140	160	180	200	225	250	280	

Cylindrical bore

Clearances in microns

Group C4	Normal series	60	75	90	110	135	160	190	220	240	260	290	320	350
		80	100	120	145	180	210	240	280	310	340	380	420	460
	EF800 series	65	85	100	120	150	180	205	240	260	285	320	355	385
		80	100	120	145	180	210	240	280	310	340	380	420	460
Group C3	Normal series	45	55	65	80	100	120	145	170	180	200	220	240	260
		60	75	90	110	135	160	190	220	240	260	290	320	350
	EF800 series	50	60	75	90	110	135	160	190	200	220	245	265	290
		60	75	90	110	135	160	190	220	240	260	290	320	350
Group C4	Normal series	30	35	40	50	60	75	95	110	120	130	140	150	170
		45	55	65	80	100	120	145	170	180	200	220	240	260
	EF800 series	35	40	50	60	75	90	110	130	140	155	165	180	200
		45	55	65	80	100	120	145	170	180	200	220	240	260

Normal series & EF800, EF801, EF802 SERIES

Comparison of clearance tolerances • Tapered bore

		Dimensions in mm.													
Nominal bore	Greater than	30	40	50	65	80	100	120	140	160	180	200	225	250	
	Up to	40	50	65	80	100	120	140	160	180	200	225	250	280	

Tapered bore (slope 1/12)

Clearances in microns

Group C4	Normal series	65	80	95	120	140	170	200	230	260	290	320	350	390
		85	100	120	150	180	220	160	300	340	370	410	450	490
	EF800 series	70	85	105	130	155	185	220	255	285	315	350	385	425
		85	100	120	150	180	220	260	300	340	370	410	450	490
Group C3	Normal series	50	60	75	95	110	135	160	180	200	220	250	270	300
		65	80	95	120	140	170	200	230	260	290	320	350	390
	EF800 series	55	65	80	100	120	145	175	195	220	245	275	295	330
		65	80	95	120	140	170	200	230	260	290	320	250	390
Group C0	Normal series	35	45	55	70	80	100	120	130	140	160	180	200	220
		50	60	75	95	110	135	160	180	200	220	250	270	300
	EF800 series	40	50	60	80	90	110	135	145	160	180	205	225	245
		50	60	75	95	110	135	160	180	200	220	250	270	300

For harsh environments: EE sealed series

EE sealed series



NTN-SNR has broadened its range of products by developing the EE sealed double-row spherical roller bearing for the ULTAGE series.

Double-row spherical roller bearings are used in a wide variety of applications including construction machinery, steelworks, power transmission for elevators, paper mills, etc.

As well as the high load capacities, there are also requirements to prevent problems of infiltration and pollution in the case of the bearings being used in a hostile environment, such as outdoors, or in a dusty atmosphere.

The ULTAGE EE double-row spherical roller bearing has been specially designed to maintain the best load capacities on the market as offered by the ULTAGE EA series, while proposing compact solutions and a constant hermetic seal even when there is bending of the shaft.

The sealed bearings are filled with a high-performance grease suited to high pressures for a longer service life. They offer high reliability, improved maintenance operations, compact solutions and improved performance while protecting the environment, in order to comply with the specifications of all types of industrial equipment.

Characteristics of the EE sealed series

- Identical internal design to the open bearings of the ULTAGE EA series
- Minimum increase of the bearing diameter to incorporate the seals (e.g., reference 22216EA: width 33 → 40 mm) identified by the prefix 10X.
- Prevents the infiltration of foreign particles and guarantees the tightness of the seal by means of constant contact pressure between lip and seal, even in the event of misalignment
- Ready to assemble with a quantity and quality of lubricant suited to high loads.

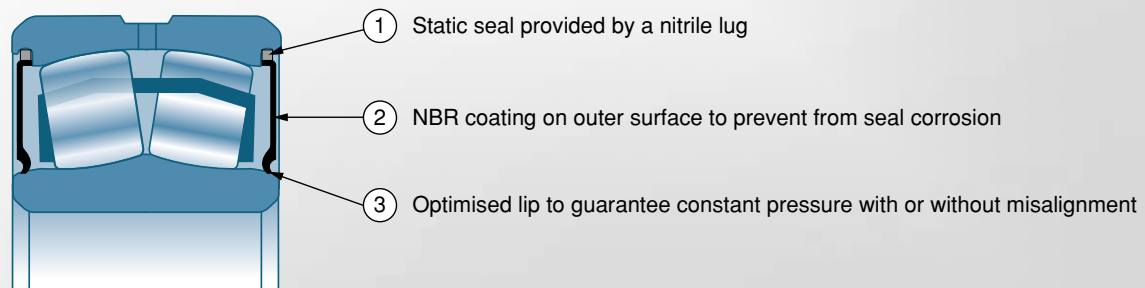

Specially designed seal contact to prevent infiltration of pollution

The geometry of the NTN-SNR seals is optimised by our finite element simulation software. It is then validated in our test laboratories under the harshest conditions in order to guarantee the reliability of the seals and their performance in your applications.

The finite element calculation method is used to study the behaviour of the seal lip under deformation and in this way optimise the global performance of the bearing in terms:

- of the seal
- of the rotation torque
- of the contact pressure

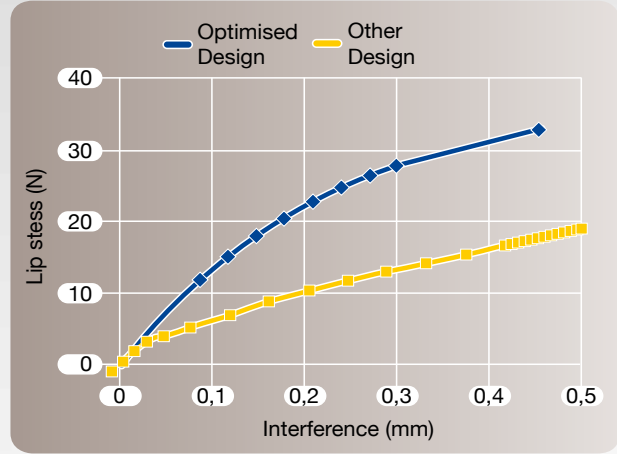
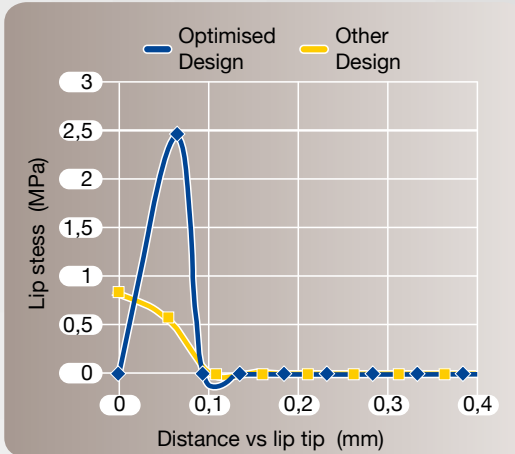

- Form of the seal gasket studied to create a contact pressure peak at the lip point, serving as a barrier preventing the infiltration of pollution and the leaking of lubricant.

- Lip force that remains sufficiently high to compensate for any interference variation due to bearing misalignment.

Validation of the calculation results on our test benches:

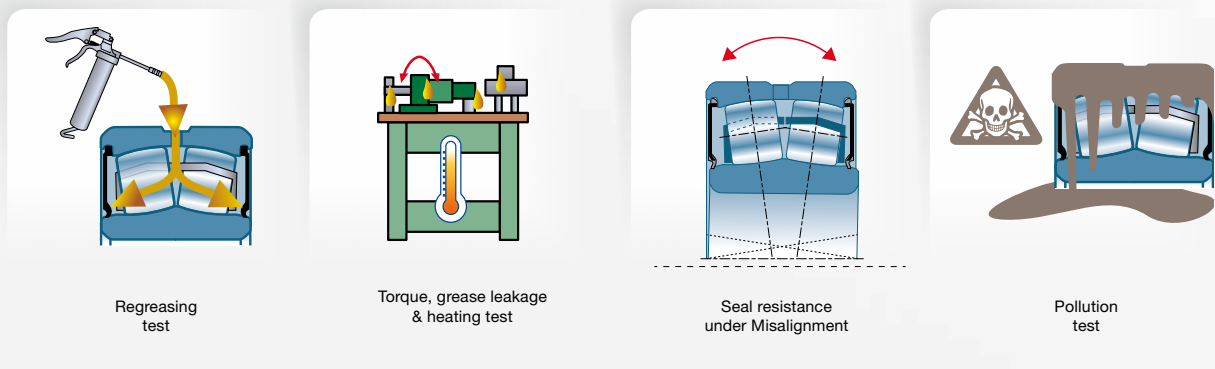

Temperature limits

NTN-SNR ULTAGE double-row spherical roller bearings can operate at temperatures of up to +110°C. For higher temperatures, the materials of the seals and the quality of the lubricant need to be adapted accordingly.

For applications where the temperature does not exceed the thermal reference of +70°C, and for low speeds, sealed bearings do not require re-lubrication. For further information, please consult our technical department.

Applications

Steel industry conveyors, mines, power transmission for elevators, printing machinery.

Solid lubrication or lifelong lubrication

The double-row spherical roller bearing, due to its internal design which forces out the lubricant for the rolling element/raceway surface contacts, is the bearing that consumes most lubricant. For this reason, for a speed factor of $N.Dm \leq 100\,000$, NTN-SNR proposes a solid lubricant concept.

The concept of a solid lubricant consists of a porous polymer matrix containing a large quantity of oil. This matrix fills the free volume of the bearing and can contain 3 to 4 times more oil than when using a traditional grease lubricant.



Spectacular performance

Solid lubrication is particularly efficient in applications where bearings are subject to:

- low-amplitude oscillations with a high risk of false brinelling. With solid lubrication, performance can be multiplied several-fold compared to the best available greases.

- High centrifugal forces up to 4000G

In applications where the bearing is subject to centrifugal phenomena, a traditional lubricant can be ejected instantaneously from the bearing, whereas a solid lubricant allows the oil to be kept within the bearing and to operate for thousands of hours.

Benefits of solid lubrication

- Longer service life. The core of the bearing is permanently supplied with oil.
- No re-lubrication required.
- Excellent resistance to centrifugal forces.
- Environmental protection: no grease leakage and very low oil leakage.
- Improved seal efficiency: protection from dust damage (can be further improved by adding grease to the body of the bearing housing).

NTN-SNR remains at your disposal to determine the suitability of this concept in your applications.

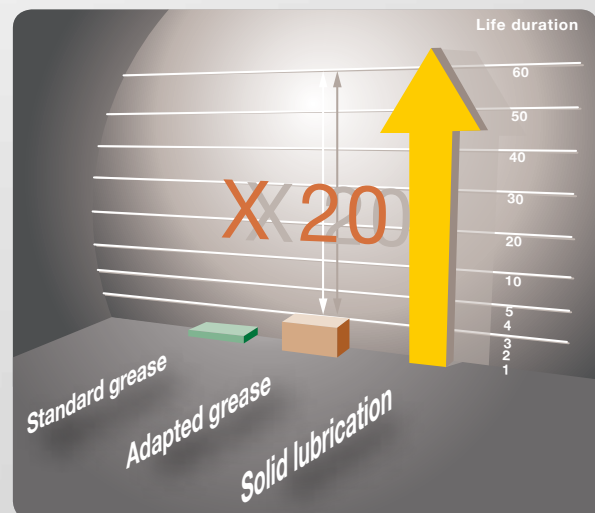

Low-noise bearings

Certain applications, such as the power transmission in elevators, are particularly demanding in terms of the noise the bearings make during operation. Safety, performance and acoustic comfort constitute important criteria and will influence the choices you make for your applications.

NTN-SNR can offer you ULTAGE spherical roller bearings with low vibration levels, identified by the suffix L. With their geometric and functional characteristics that are optimised to generate minimum vibrations, these bearings offer significant improvements in terms of noise levels, and are particularly suited to elevator power transmissions and any application where acoustic comfort is a prime consideration.

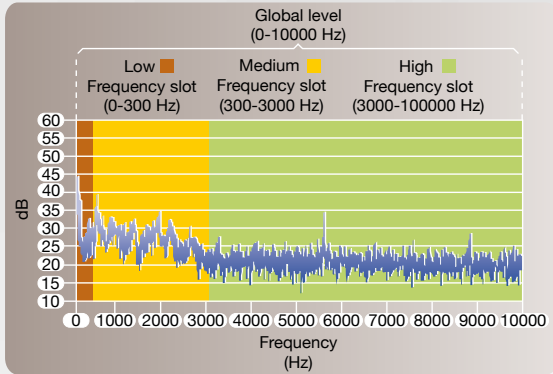

Example of the acoustic spectrum measured on a spherical roller bearing.

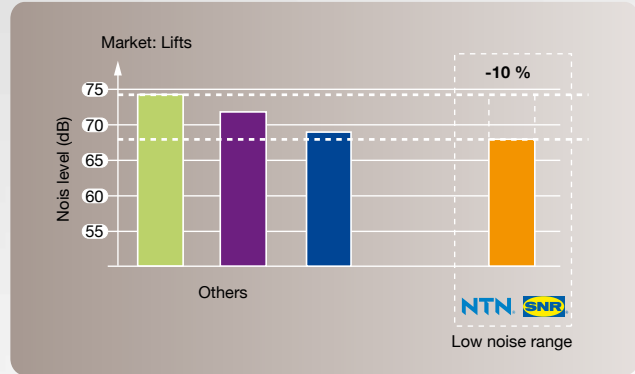

Histogram of the noise level for an elevator transmission application.

For further information about the availability of low-noise bearings, please contact your NTN-SNR representative.

Special treatment for hard-to-lubricate applications or polluted lubrication

Increased service life

When bearings operate in conditions of deficient or polluted lubrication (e.g., industrial power transmission), service life is considerably reduced on account of the concentrated stresses generated:

- in contact with the surface irregularities
 - on the edges of the indents left by particles or debris transported by the lubricant across the contact surface
- This mode of operation can, however, be improved by optimizing the material / heat treatment pairing.

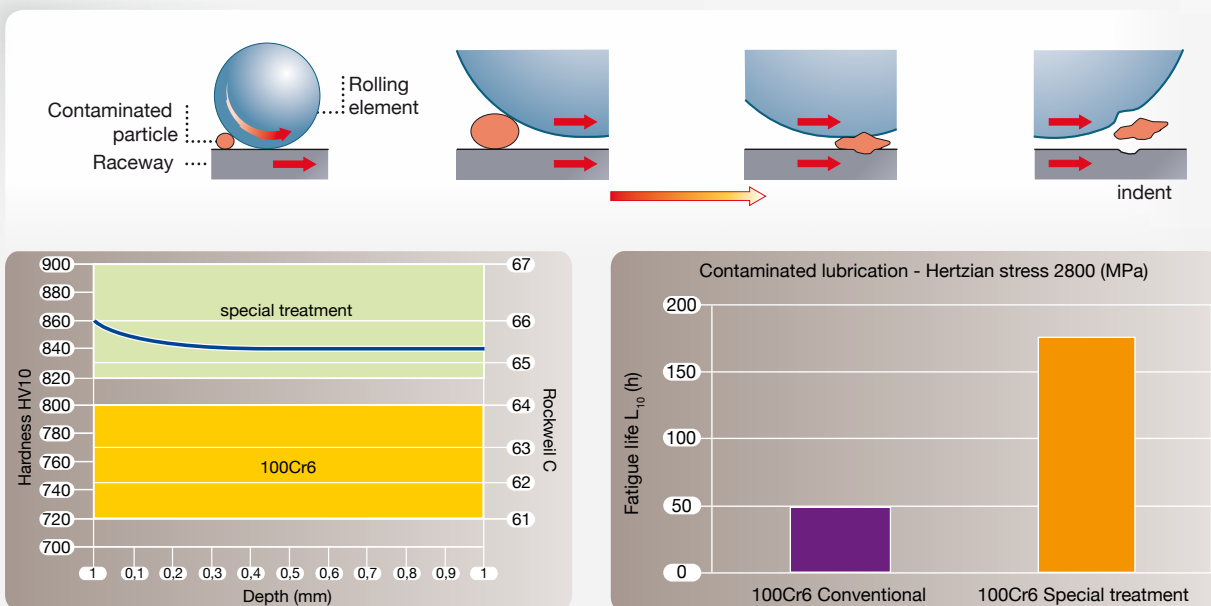

NTN-SNR offers you a solution by carrying out specific surface treatment designed both

- to increase the surface hardness
- to optimise the residual austenite content, along with the level of residual compressive stresses of the surface layer.

This makes it possible to limit the size of the indents linked to pollution as well as limiting the formation and propagation of cracks emanating from their edges.

For a specific study of your application, please contact your NTN-SNR representative.

- Surface hardness obtained: 840 – 900HV
- Residual austenite content between 15 and 20%
- Average compressive stress in the order of 200 MPa in the treated layer.

→ The service life with polluted lubrication is therefore increased consistently (factor of x2 minimum) compared to 100Cr6 when treated conventionally.

Bearings with reinforced steel plate cages

Endurance under cost control

In order to complete its product offering and propose an economic alternative to solid cages for applications with high-performance requirements, such as railway, steel industry or industrial power transmission applications, NTN-SNR has developed an oxynitrocarburizing treatment

for the EA series steel plate cages. This treatment allows the surface structure of the steel to be modified by creating a very hard, compact combination layer and a diffusion layer containing metallic nitrides in needle form.

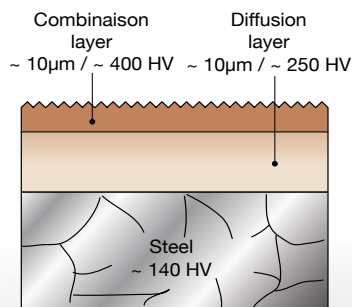

Technical drawing of steel cage microstructure with oxynitrocarburizing treatment



Treatment characteristics

- This thermo-chemical treatment allows the surface hardness of the cage to be increased, thereby improving its resistance to wear and tear.
- The resilience in the steel core is maintained in order to ensure excellent cage resistance to mechanical fatigue.
- The micro-cavities, obtained on the surface, enable the

tribological properties to be improved while creating reserves of lubricant and contributing to reduced friction in the bearing.

The creation of a passivated surface layer, formed of black iron oxide, improves the corrosion resistance.

For further information about the available product references and a study of your needs, please contact your NTN-SNR representative.





Part 4

Technical recommendations

• Nominal service life	32
• Adjusted nominal service life	33
• Method for determining a_{iso} (ISO 281 standard)	34
• Speeds	36
• Lubrication	39
• Mounting and removal	44

Nominal service life

The nominal service life, L_{10} , recommended by the standard ISO 281, is given by the equation $L_{10} = (C/P)^n$ or $n=10/3$ where $n=10/3$ for the roller bearings. This equation is defined for a reliability level of 90% under normal operating conditions.

$$L_{10} = (C/P)^n \text{ in millions of revs}$$

or

$$L_{10} = (C/P)^n \cdot 10^6 / 60N \text{ in hours}$$

C = Basic dynamic load, (Newton)

P = Equivalent dynamic load, (Newton)

N: Rotation speed (rpm)

→ Equivalent dynamic load P

$$P = F_r + Y_1 \cdot F_a \text{ where } F_a/F_r \leq e$$

$$P = 0.67F_r + Y_2 \cdot F_a \text{ where } F_a/F_r > e$$

P = Equivalent dynamic load, N

F_r = Dynamic radial load, N

F_a = Dynamic axial load, N

e, Y_1, Y_2 factors according to dimensions tables

→ Equivalent static load P_0

$$P_0 = F_{or} + Y_0 \cdot F_{oa}$$

P_0 = Equivalent static load, N

F_{or} = Static radial load, N

F_{oa} = Static axial load, N

Y_0 = Factor according to dimensions tables

→ Safety factor

$$f_s = C_0 / P_0$$

C_0 basic static capacity defined in the dimensions tables, (Newton)

Minimum basic values for the static safety coefficient f_s :

- 1.5 to 3 for severe conditions
- 1 to 1.5 for normal conditions
- 0.5 to 1 for operations with no particular noise or precision requirements

If you are looking for a bearing operating under harsh conditions, the safety coefficient f_s must be high.

→ Minimum radial load

In order to avoid slippage phenomena between the rolling elements and the raceways, in particular in the case of high speeds or accelerations, a minimum load must be applied to double-row spherical roller bearings.

$$P_{mm} = 0.01C_0$$

P_{mm} = minimum radial load, (Newton)

C_0 = basic static load, (Newton)

→ Axial load

Double-row spherical roller bearings can support high axial loads. However, the recommendation is not to exceed the value $F_a/F_r = 0.3$.

In the event of high loads combined with high speeds, the rise in the bearing temperature must be taken into account.

Adjusted nominal service life

• **The basic nominal service life L_{10}** is often a satisfactory estimation of the bearing performance levels. This service life is understood to accommodate 90% reliability and conventional operating conditions. It may be necessary in certain applications to calculate the service life for a different level of reliability or for specific lubrication and contamination conditions.

With steels for high-quality bearings, it is possible, for low loads and under favourable operating conditions, to obtain extremely long service lives compared to L_{10} . A shorter service life than L_{10} may apply under unfavourable operating conditions.

Below a certain load C_u (defined in the ISO 281 standard as «the fatigue load limit»), a modern high-quality bearing can achieve a practically infinite service life if the lubrication conditions, cleanliness and other operating conditions are favourable.

This load C_u can be determined precisely according to:

- the types of bearing
- their internal geometry
- the fatigue limit of the raceway material

The ISO 281 standard provides the necessary formula for obtaining a sufficient approximation based on the static capacity of the bearing.

• **The ISO 281 international standard** introduces a correction factor of duration a_{iso} which enables an adjusted nominal service life to be calculated according to the formula:

$$L_{nm} = a_1 a_{iso} L_{10}$$

The coefficient a_1 is designed to calculate the duration for a reliability level different to 90% of the original formula.

The coefficient a_{iso} is used to estimate the influence of the lubricant and of the contamination on the bearing service life. It takes account of the fatigue limit of the bearing steel.

Since the evaluation method for a_{iso} defined by ISO 281 is fairly difficult to apply by a non-specialist user, NTN-SNR has looked for the best way to supply its customers with an easy way of determining a_{iso} based on the hypotheses of the standard.

- that the fatigue load C_u depends directly on the static capacity of the bearing,
- that the contamination factor is constant whatever the lubrication conditions and the average diameter of the bearing.

The method proposed by NTN-SNR enables rapid, graphic evaluation of the coefficient a_{iso} .

Our engineers are at your disposal to determine this coefficient more precisely if required.

Method for determining a_{ISO} (ISO 281 standard)

The following diagram can be used to determine a_{ISO} for double-row spherical roller bearings according to the following method:

1. Define the viscosity of the lubricant at the operating temperature based on the diagram on page 36
Determine the viscosity of the base oil for greased bearings.
2. Define the pollution level:
 - **High cleanliness**
Oil filtered through an extremely fine filter; usual conditions for bearings that are greased for life and sealed.
 - **Normal cleanliness**
Oil filtered through a fine filter; usual conditions for bearings that are greased for life and equipped with a shield.
 - **Slight contamination**
Slight contamination in the lubricant
 - **Typical contamination**
Oil with coarse filtration; presence of wear and tear particles or particles from the surrounding environment. Usual conditions for lubricated bearings with no integrated seal.
 - For **major contamination**, consider that a_{ISO} will be less than 0.1
3. Based on the loads applied to the bearing, calculate the equivalent load P and the static capacity / equivalent load ratio: C_0 / P .
4. In graph 1, determine point **1** according to the pollution level and the value C_0 / P .
5. Determine point **2** based on the average diameter of the bearing:
 $D_m = (\text{bore} + \text{outer diameter}) / 2$
6. Determine point **3** according to the rotational speed of the bearing.
7. Determine point **4** according to the viscosity of the lubricant at the operating temperature.
8. Point **5** at the intersection between the straight lines deriving from points 2 and 4 defines the value zone for a_{ISO} .

Roller bearings: estimation of coefficient a_{ISO}

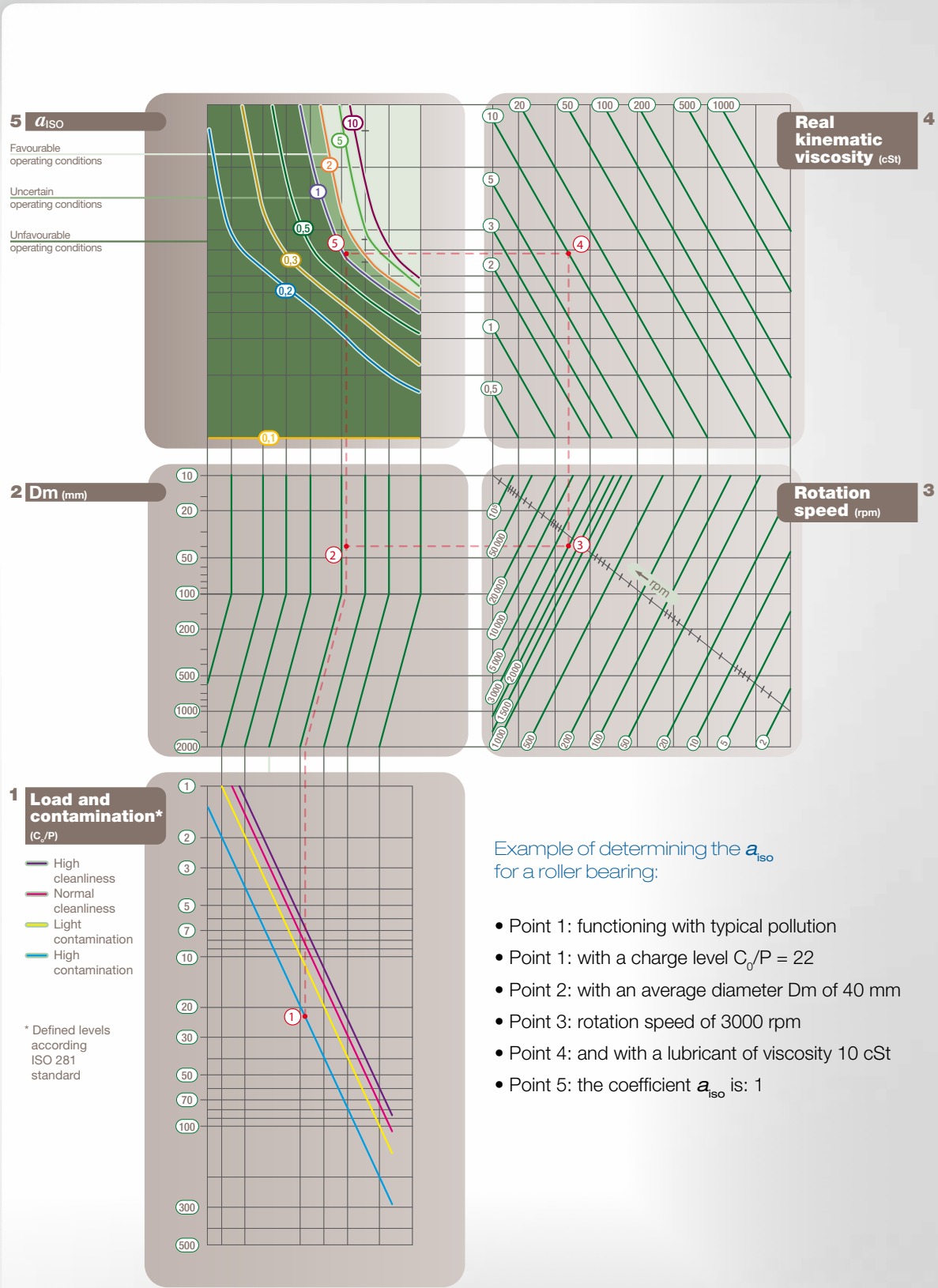

Example of determining the a_{ISO} for a roller bearing:

- Point 1: functioning with typical pollution
- Point 1: with a charge level $C_v/P = 22$
- Point 2: with an average diameter D_m of 40 mm
- Point 3: rotation speed of 3000 rpm
- Point 4: and with a lubricant of viscosity 10 cSt
- Point 5: the coefficient a_{ISO} is: 1

* Defined levels according ISO 281 standard

Determining the minimum viscosity required for the operating temperature

Determining the minimum necessary viscosity

Determining the minimum required viscosity

The oils used for lubricating bearings are generally mineral oils with a viscosity in the vicinity of 90. The suppliers of these oils state the precise characteristics of their products

and, in particular, the viscosity-temperature diagram. Failing this, the following general diagram will be used.

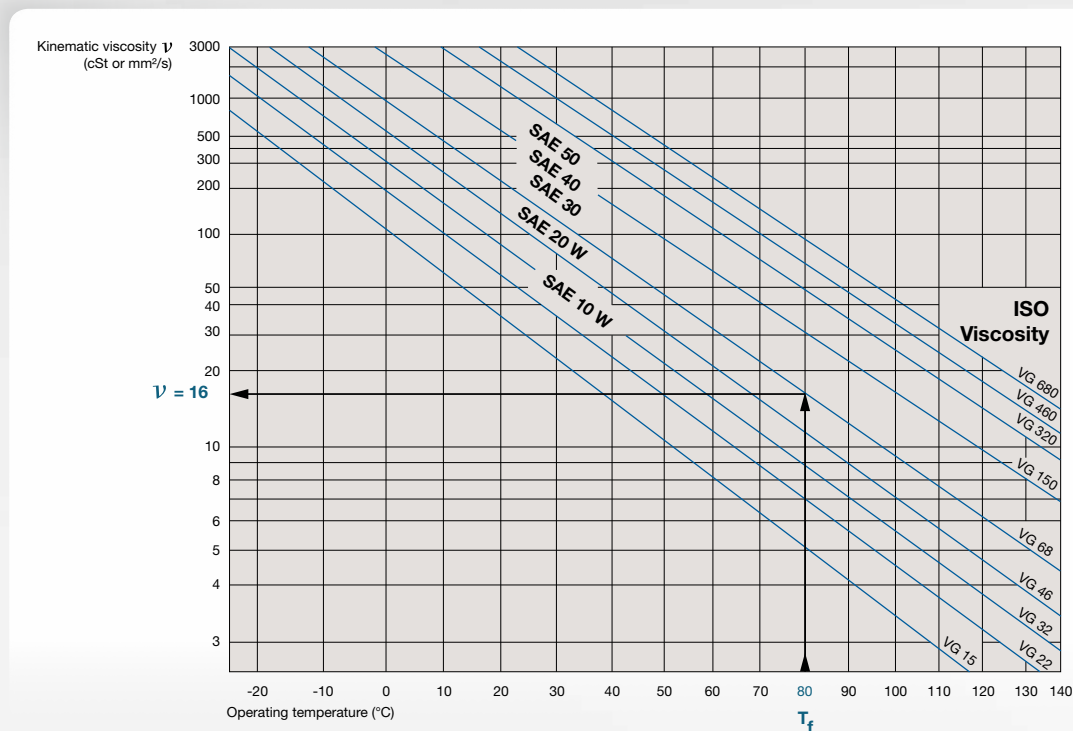

Since the oil is defined by its nominal viscosity (in centistokes) at the nominal temperature of 40°C, the viscosity at the operating temperature may be deduced.

Speeds

Thermal reference speed n_{θ_r}

The thermal reference speed is the rotational speed of the inner ring at which a thermal equilibrium is attained between the heat produced by the friction in the bearing and the heat flow emitted via the contact surface (shaft and housing) of the bearing under reference conditions.

The reference speed values indicated in the tables are in compliance with standard ISO 15312. The reference conditions for this standard have been chosen to apply both for oil lubrication and for grease lubrication. This standard applies to bearings up to and including a bore diameter of 1000 mm.

Reference conditions determining the formation of heat through friction:

- Fixed reference temperature of the bearing on the outer ring θ_r : 70°C
- Reference ambient temperature of the bearing θ_{Ar} : 20°C
- Reference load $P_{1r} = 0.05 \times C_{Or}$ (5% of the basic static radial load, as pure radial load)
- Lubricant: high-pressure, additive-free mineral oil with, at $\theta_r = 70^\circ\text{C}$, a kinematic viscosity of $\nu_r = 12\text{mm}^2/\text{s}$ (ISO VG32)

Mathematical calculation according to standard ISO 15312

$$\frac{\pi \cdot n_{\theta r}}{30 \cdot 10^3} \cdot [10^{-7} \cdot f_{\theta r} \cdot (\nu_r \cdot n_{\theta r})^{2/3} \cdot d_m^3 + f_{1r} \cdot P_{1r} \cdot d_m] = q_r \cdot A_r$$

$n_{\theta r}$: Thermal reference speed

$f_{\theta r}$: Adjustment factor for the moment of friction independent of the load (the values as per ISO 15312 are for information purposes only)

f_{1r} : Adjustment factor for the moment of friction depending on the load (the values as per ISO 15312 are for information purposes only)

ν_r : Kinematic viscosity of the lubricant

d_m : Average diameter of the bearing $D_m = 0.5(D+d)$

q_r : Reference thermal flow density $q_r = 0.016 \text{ W/mm}^2$. If $A_r > 50000 \text{ mm}^2$ then $q_r = 0.016(A_r/50000)^{-0.34}$

A_r : Reference thermogenic surface area $A_r = \pi \times B(D+d)$

Limiting speed

The limiting speed is the maximum permissible speed which depends on the mechanical limits, such as the tensile strength of the constituent parts of the bearing. The limiting rotational speed is based on practical experiments.

It takes account of additional criteria such as silent operation, the seal functions, the stability or resistance of the cage, the lubrication of the cage guide surfaces, the centrifugal and gyrating forces that act on the rolling elements and other speed limitation factors.

Thermally safe operating speed

The thermally safe operating speed n_{adm} is the rotational speed at which the average temperature of the bearing reaches the permissible limiting value under actual operating conditions. To determine the thermally safe operating speed of the bearing in its application, it is necessary to take account of the influence of the load and of the kinematic viscosity on the reference speed. When the load and viscosity parameters are in excess of the

reference values, the friction resistance will increase and the temperature of the bearing will be higher. In this case, the bearing cannot operate at the thermally safe reference speed unless higher temperatures are permitted by the bearing and its application.

The influence of the load and of the kinematic viscosity of the lubricant may be determined on the basis of diagrams 1 and 2, page 38.

Oil lubrication

- f_p : for the influence of the equivalent dynamic load P
- f_v : for the influence of the viscosity

If the reference temperature needs to remain constant at 70°C, the thermally safe operating speed is determined based on:

$$n_{adm} = n_{\theta r} \cdot f_p \cdot f_v$$

- n_{adm} = thermally safe operating speed of the bearing, rpm
- $n_{\theta r}$ = thermal reference speed
- f_p = adjustment factor for the equivalent dynamic load P
- f_v = adjustment factor for the oil viscosity

Grease lubrication

The diagram for determining factor f_v is also suitable for grease lubrication.
 In this case, the standard stipulates a kinematic viscosity of the base oil of between ISO VG 100 and ISO VG200 at +40°C with a quantity of grease equal to 30% of the free volume in the bearing.

To determine factor f_v in the case of grease lubrication, select the value of f_v from diagram 1 for the viscosity of the base oil at +40°C for the chosen grease and divide by f_v for the viscosity of the base oil ISO VG 150 (average value of the base oils permitted by the standard)

$$n_{adm} = n_{gr} \cdot f_p \cdot \frac{f_v \text{ real viscosity of the base oil}}{f_v \text{ viscosity of the base oil ISO VG 150}}$$

Example

An NTN-SNR ULTAGE 22216EA spherical roller bearing with a factor of $P/C_0=0.2$ lubricated with a oil of oil viscosity of ISO VG 220 mm²/s at 40°C.

Thermally safe operating speed:

$$d_m = 0.5(80+140) = 110\text{mm}$$

$$n_{gr} = 4200 \text{ rpm}$$

In diagram 1: $f_v = 0,77$

In diagram 2: $f_p = 0,55$

The thermally safe operating speed in these conditions is:

$$N_{adm} = 4200 \times 0,77 \times 0,55 = 1780 \text{ rpm}$$

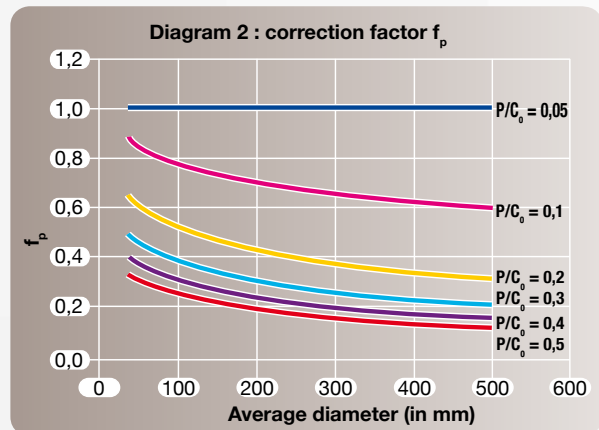
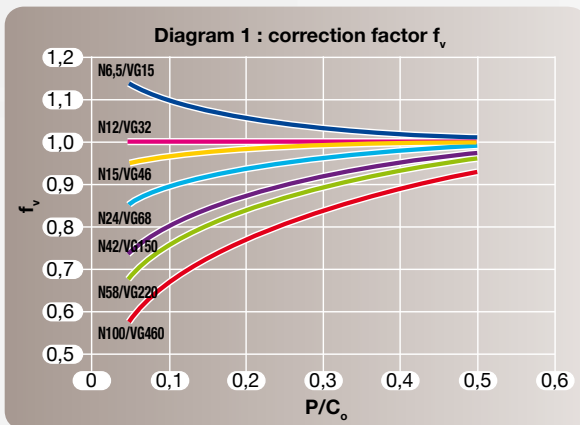

In the case of operation at speeds approaching the limits stated in the bearing tables, please contact your NTN-SNR representative.

Lubrication

What the experts say

Only correct lubrication will guarantee optimal operation of the bearing and of the associated mechanical unit.

Our field experience shows that

- 55% of premature faults with bearings result from inappropriate lubrication.
- imperfect lubrication significantly reduces the service life of the bearing

It has been observed that lubrication operations are often neglected on account of the difficulty of accessing the bearings and inadequate knowledge of the properties of many lubricants on the part of the user.

Since the choice of lubricant, the method of lubrication, the precise quantity to inject into the bearing and the monitoring frequency need to be studied carefully, our teams are on hand to advise you.

Principle and benefits of good lubrication

- By interposing a film of lubricant (oil film) between the rolling elements and the raceway, this prevents wear and tear and seizure of the elements through metal-to-metal contact.
- It also protects the parts from corrosion.
- It provides a seal against liquids and external pollution and eliminates the impurities created by the movement of the parts.
- It reduces friction, and therefore limits the power consumed by the machine, thereby reducing energy costs.
- In the case of oil circulation, it evacuates the heat build-up and thus contributes to the thermal equilibrium of the machine.

- on the characteristics of the lubricant and therefore on its capability to resist high temperatures and vibrations, etc.
- on the load conditions and the bearing rotation speed

General-purpose greases do not always correspond to the specific requirements of certain applications. Since the bearings have to operate under conditions of high load, speed or temperature, or in the presence of water, humidity or vibrations, they require the use of carefully-selected lubricants.

NTN-SNR has consistently been involved in research in this field with the world's top lubricant manufacturers. In this way we have built up knowledge and practical experience of most of the lubricants applicable to bearings.

The service life of the bearing is directly linked to the efficiency of the oil film, which depends:

Choice of lubricant type

	OIL LUBRICATION	GREASE LUBRICATION
BENEFITS	<ul style="list-style-type: none"> • Good bearing penetration • Good physical-chemical stability • Cooling • Easy control of the lubricant: state and level 	<ul style="list-style-type: none"> • Cleanliness of the mechanism • Easier to ensure a good seal • Protective barrier • Easy assembly • Easy handling • Reduced or zero lubricant top ups • Possible use of pre-lubricated bearings
DRAWBACKS	<ul style="list-style-type: none"> • Perfect seal required on assembly • In the event of prolonged stoppage, poor protection against oxidation and humidity • Start-up delays when independent circulation prior to rotation is required 	<ul style="list-style-type: none"> • Higher friction coefficient than with oil • Inferior heat evacuation • Replacement (if needed) requires removal and cleaning of the bearing • No possibility of checking the grease level, therefore necessary to use a reliable grease periodically top-up in order to compensate for leakage, pollution or ageing

Characteristics of greases

A grease is a semi-fluid to solid product obtained by dispersal of a thickening agent (soap) in a lubricating liquid (mineral or synthetic oil).

To provide certain specific properties, additives may be included. The growing use of bearings lubricated with grease, associated with the development of lifelong lubrication, makes the grease an integral component of the bearing. The service life of the bearing and its behaviour in various environments are largely determined by the properties of the grease used.

Physical-chemical characteristics

Consistency

- The NLGI (National Lubrication Grease Institute) grade corresponds to a penetration value in the grease used (according to test specification ASTM/D217).
- For bearings, the chosen consistency is in general grade 2.

NLGI GRADES	PENETRATION	CONSISTENCY
0	385 - 355	Semi-fluid
1	340 - 310	Very soft
2	295 - 265	Medium soft
3	250 - 220	
4	205 - 175	Semi-hard

Base oil viscosity: generally defined in cSt (mm²/s) à 40°C

Density: in the order of 0.9

Drop point: temperature at which the first liquefied drop falls following heating of a sample

Order of magnitude: 180°C/260°C depending on the constituent components of the grease. The maximum temperature of use of the grease is always far below the drop point.

Functional specifications

The working conditions to which the lubricant is subjected (rolling, blending) require special bearing greases that cannot be selected exclusively on the basis of their physical-chemical characteristics.

The NTN-SNR Research & Testing centre is constantly carrying out approval tests on bearings to allow us to provide advice about the grease best suited to a given application.

The approval specifications relate to the following basic criteria:

- endurance of ball-bearings
- endurance of roller bearings
- water resistance
- resistance at high and low temperatures
- adherence (centrifugation)
- resistance to vibrations (false brinelling)
- resistance to high speeds
- etc.

These criteria may be supplemented depending on the result that the customer seeks. Grease selection for a particular application is a compromise carried out on the basis of the technical specifications of the application.

For further information about the technical characteristics of lubricants and their selection criteria, please consult our Experts & Tools catalogues or contact your NTN-SNR representative.

TOOLS FOR CALCULATING BEARING LUBRICATION NEEDS

CHOICE OF LUBRICANT VISCOSITY (OIL OR GREASE)

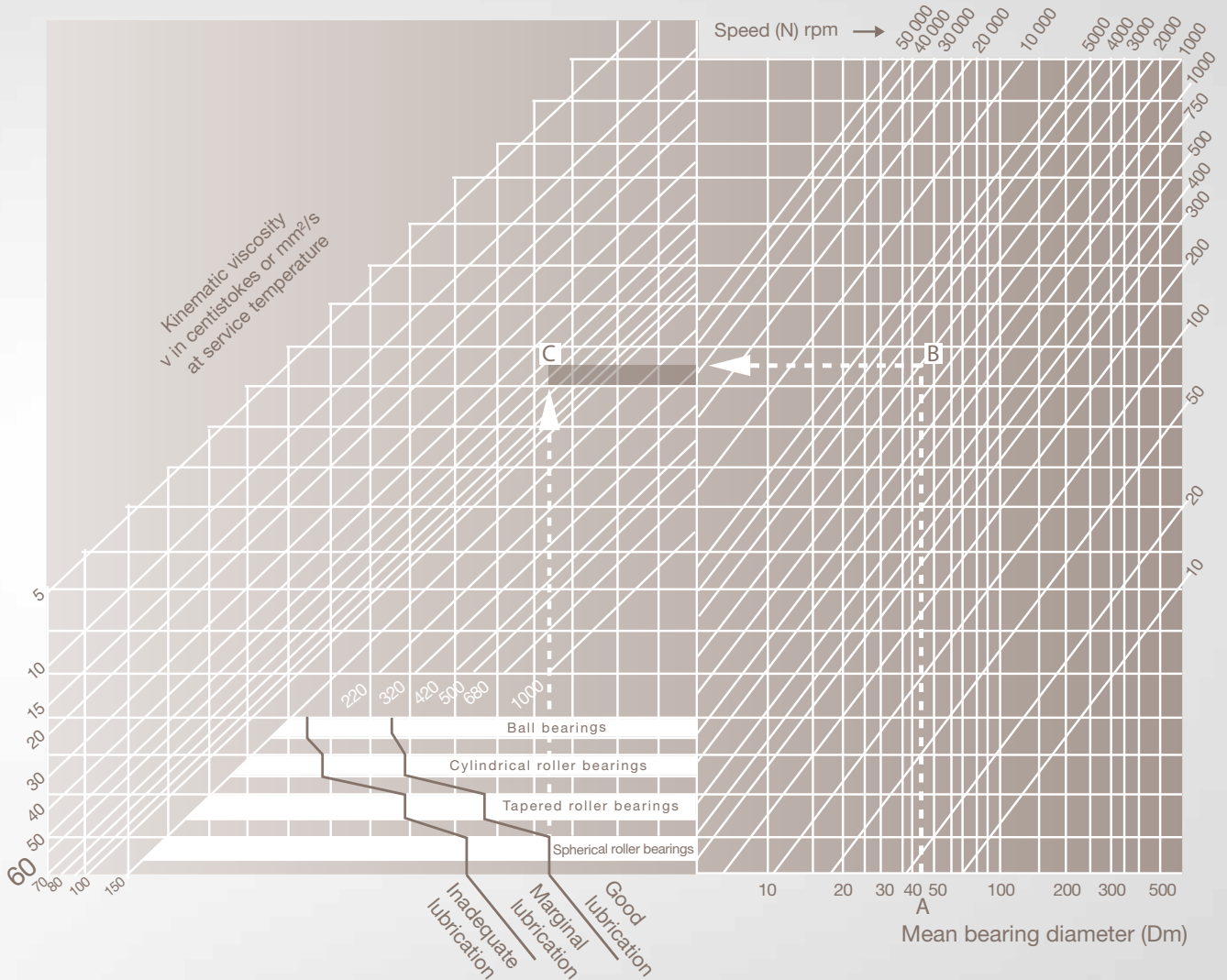

- Determine the average diameter of the bearing $A = (\text{Bore} + \text{external diameter})/2$
- Find, by following point B on the graph, the intersection with the bearing rotation speed line
- Identify point C, intersection of the horizontal line deriving from B and the vertical line starting from the efficient lubrication limit, according to the type of bearing
- Determine the value of the oblique line passing via C (60 in the present case)
- You then need to calculate the viscosity of the lubricant to be chosen, taking account of the operating temperature of the bearing

On the vertical scale (on table p36), note the value of the calculated basic viscosity.

Identify the intersection between this value and the operating temperature of the bearing

The desired viscosity is the value of the oblique line passing via this intersection (approximately SAE 50, or VG300 in the present case)

DOSAGE OF LUBRICANTS AND RELUBRICATION

OIL LUBRICATION (MINIMUM QUANTITY)

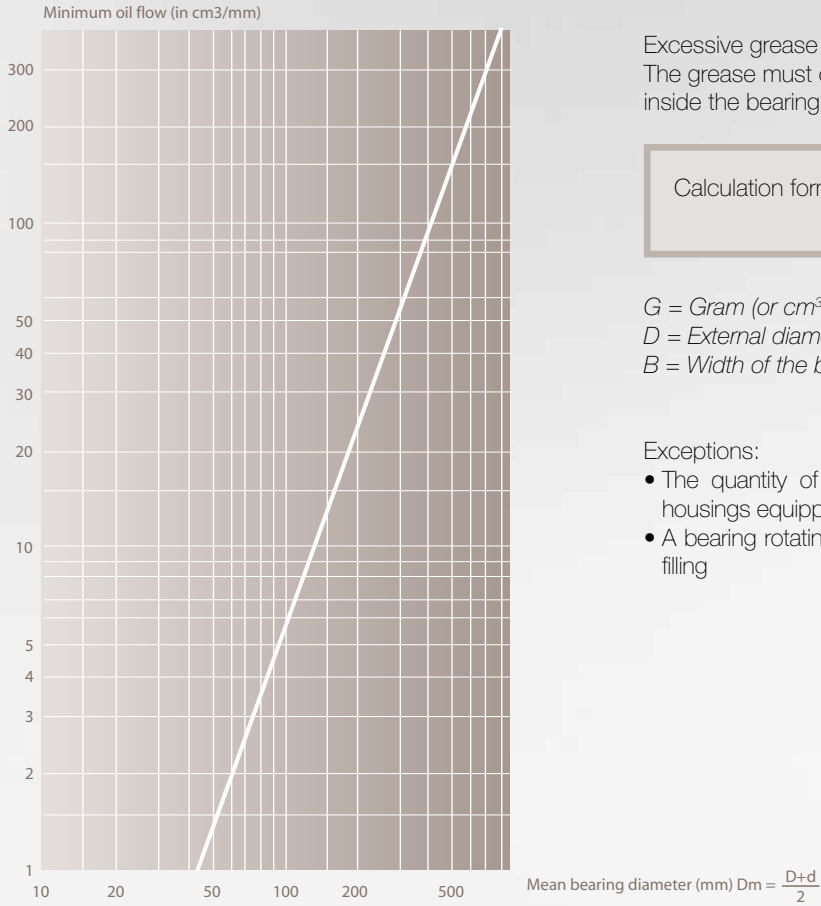

LUBRICATION WITH GREASE (DOSAGE)

Excessive grease may cause overheating. The grease must occupy 20 to 30% of the free volume inside the bearing.

Calculation formula for the weight of grease required:
 $G = 0,005 D.B$

G = Gram (or cm³)
 D = External diameter of the bearing in mm
 B = Width of the bearing in mm

Exceptions:

- The quantity of grease may be increased by 20% for housings equipped with a grease evacuation orifice
- A bearing rotating a very low speed will tolerate complete filling

RELUBRICATION FREQUENCY

Basic frequency in hours

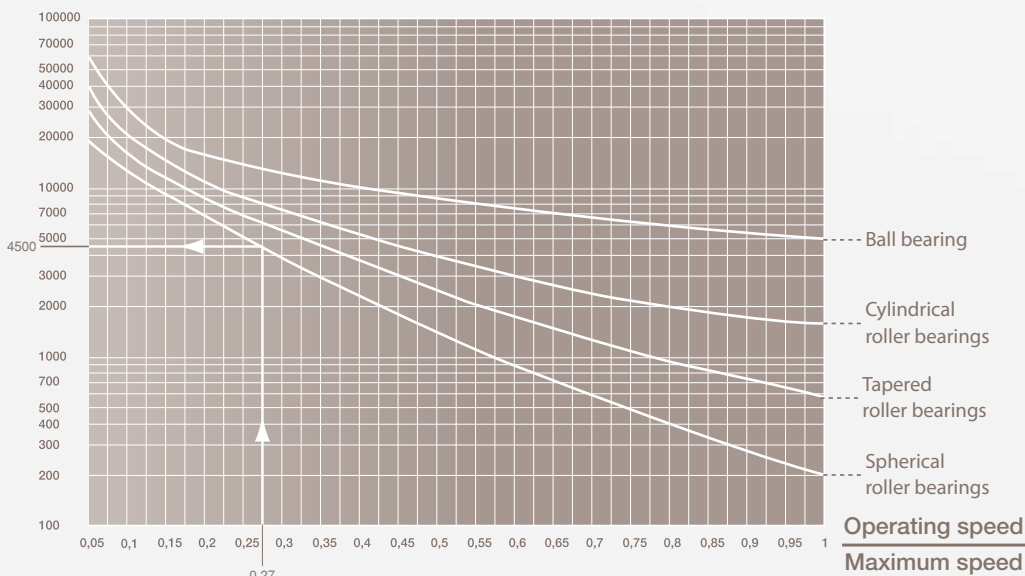

The basic relubrication frequency (F_b) depends on the type of bearing and the ratio of the speed of usage to the limiting speed stated in the bearing specifications.

This basic frequency needs to be adjusted by the following coefficients according to the specific environmental conditions of the mechanism (dust, humidity, impacts, vibration, vertical axis, operating temperature, etc) according to the relation: $F_c = F_b \times T_e \times T_a \times T_t$

Environment		Applications	Temperature		
Conditions	Dust Humidity Condensation	With impacts Vibrations Vertical axis	Level	For standard grease	For high-temperature grease
Coefficients	T_e	T_a		T_t	T_t
Mean	0,7 to 0,9	0,7 to 0,9	75°C	0,7 to 0,9	-
High	0,4 to 0,7	0,4 to 0,7	75°C to 85 °C	0,4 to 0,7	0,7 to 0,9
Very high	0,1 to 0,4	0,1 to 0,4	85°C to 125 °C	0,1 to 0,4	0,4 to 0,7
	-	-	130°C to 170 °C	-	0,1 to 0,4

Example: a 22212EA bearing, lubricated with standard grease, turning at 1500 rpm in a dusty environment, at 90°C with no other application constraints:
 22212 = spherical roller bearing
 Reference thermic speed = 5600 rpm
 Utilisation speed = 1500 rpm

$\frac{\text{Utilisation speed} = 1500 \text{ rpm}}{n_{gr} \text{ speed} = 5600 \text{ rpm}} = \frac{1500}{5600} = 0,27 \longrightarrow \text{Basic frequency } F_b = 4500h$ $\text{Corrected frequency } F_c = 4500 \times 0,5 \times 0,9 \times 0,3 = 600h$	$T_e = 0,5 \longrightarrow \text{dust}$ $T_a = 0,9 \longrightarrow \text{normal}$ $T_t = 0,3 \longrightarrow 90^\circ\text{C}$
---	--

WEIGHT OF GREASE TO BE RENEWED

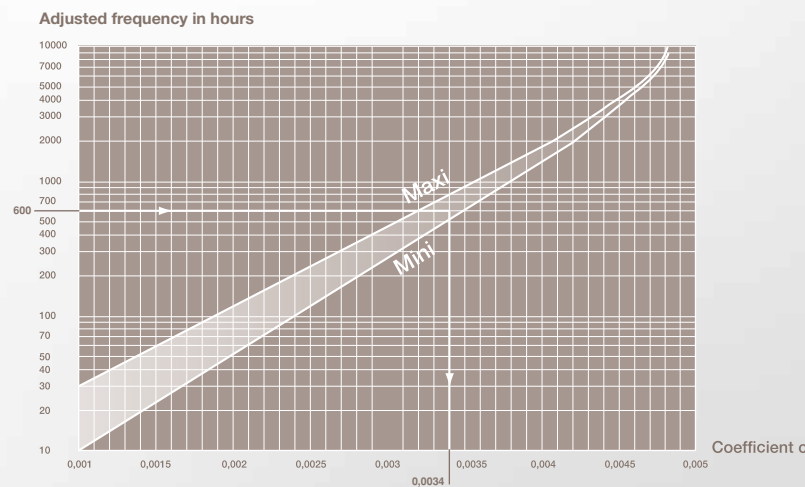

This adjusted frequency is used to determine the weight of the grease to be used, according to:

- the bearing width B
- its external diameter D
- coefficient c read off the following curve by the relation $P = D \times B \times c$ hence $P = \text{weight of grease (gramm)}$

Example:
 for the 22212
 (D=110, B=28)
 $P = 110 \times 28 \times 0,0034 = 10$
 We shall therefore add approximately 10 g every 600 hours of operation.

In first approximation, we may consider the following values:

FLOW RATE ADJUSTMENT PARAMETERS

Shaft diameter	Manual lubrication frequency (one pump action = 1 cm³)	Quantity per day	Frequency of replacement of automatic lubricator 120 to 130 cm³
100 to 120 mm	4 pump actions per day	3 to 4 cm³	1 month
80 to 100 mm	2 pump actions per day	2 cm³	2 months
65 to 80 mm	8 to 10 pump actions per week	1,5 cm³	3 months
50 to 65 mm	8 to 10 pump actions every 15 days	0,7 cm³	6 months
< 50 mm	8 to 10 pump actions per month	0,3 cm³	12 months

Mounting and removal

What the experts say

Mounting the bearing is an essential stage that determines the service life and proper functioning of the installation.

The experience of the millions of NTN-SNR bearings on the market has allowed us to collate very precise statistics about the source of material failures. This data gathering has brought to light an essential fact: it is rare for the bearing itself to be responsible for a premature breakdown. In 90% of cases, the causes are to be found in external factors that can be classified into 4 broad families:

- **Inappropriate lubrication (55%)**

Inappropriate or incorrect lubrication significantly reduces the service life of the bearing.

NTN-SNR can provide you with a specific service, and markets a comprehensive range of greases suited to each type of application, along with a selection of automatic lubrication systems.

- **Pollution (18%)**

The environment in which bearings have to operate is often highly polluted. Dust, liquid detergents, etc., are elements that significantly reduce the service life of bearings.

To address these issues, NTN-SNR has developed a wide range of seals and will support you in making the choice best suited to your application.

- **Incorrect mounting (17%)**

The mounting of a bearing in a machine is a key stage that will determine its service life. A bearing that has not been mounted correctly is likely to sustain rapid damage.

This damage may be manifested by abnormal noises. It will lead in the short term to surface fatigue on the bearing. NTN-SNR can take charge of mounting and removal

operations, or else provide you with the training, the tools and the equipment to make these operations safer and easier.

- **Fatigue (10%)**

Bearings are focal points at which material fatigue is likely to be manifested. The stresses to which they are subject are often exacerbated by the fact that they rarely operate under optimal conditions (machine overload, insufficient lubrication, etc.). The stresses that the active surfaces of the bearings have to sustain ultimately lead to surface damage through flaking. This phenomenon is normal and signifies the «natural death» of the bearing.

Our supervision methods and the support of our experts allow you to act at the first signs of weakness and organise the appropriate maintenance operations.

Cold fitting

Cold fitting is the simplest mode of assembly. It is particularly suited to small and medium-sized bearings with a moderately tight fit.

Among the most frequently observed problems:

- inappropriate fittings or damaged seats
- impacts or forced / incorrectly applied fitting, leading to damage of the rings and seals or scratching of the raceways
- involuntary introduction of particles or liquids present in the assembly environment

NTN-SNR recommendations

Rule 1: the bearing must be tightened on the rotating element to which it is fitted.

	Rotation analysis (frequency of cases)		Attachment
Fixed load with respect to the outer ring	Fixed housing and load (95%) 	Rotating housing and load (0.5%) 	Inner ring tight on shaft
	Rotating inner ring	Fixed inner ring	
Fixed load with respect to the inner ring	Fixed shaft and load (3%) 	Rotating shaft and load (1.5%) 	Outer ring tight in housing
	Rotating outer ring	Fixed outer ring	

Rule 2: the sleeve-fitting is carried out by pressing against the bearing ring where the fit is the tightest or simultaneously on the two rings. In this way you avoid excessive stress on the rollers and damage to the bearing.

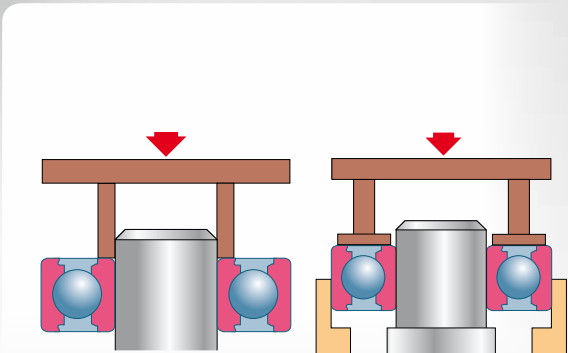

Special case of a smooth shaft for mounting requiring a tight fit and longitudinal adjustment of the bearing: use a mechanical sleeve with tapered seat associated with a tapered bore bearing

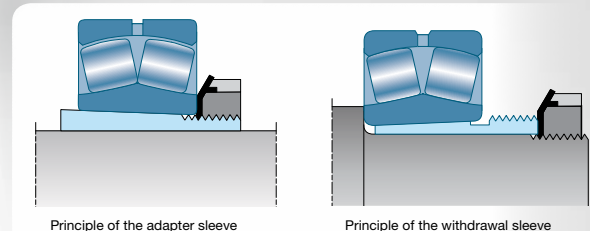

What the NTN-SNR experts have to say:

For easier mounting and in order to avoid contact-corrosion with the shaft or housing:

- always use NTN-SNR fitting compound. This thick lubricant preserves the surface quality of parts with mating surfaces. Without this compound, corrosion would progressively cause the fit between bearing and shaft (or housing) to

deteriorate, ultimately leading to vibrations and ring rotation, causing premature damage to the bearing and the mating surfaces.

- avoid introducing any pollutant during assembly (metal chips, liquid, etc.)

Hot fitting

hot fitting: raising the temperature of the inner ring causes it to expand in order that it can fit effortlessly onto its shaft.

- In the event of tight fitting on the outer ring, prior to the insertion of the bearing, the housing may be made to expand through heating.
- Conversely, a shaft or a bearing ring can also be frozen using liquefied gas in order to facilitate insertion of the bearing.

generate temperatures locally that alter the hardness of the bearing, and therefore shorten its service life.

NTN-SNR induction heating devices offer the best solution in terms of safety, cleanliness and rapidity compared to heating by means of oil bath, hot plate or oven.

Heating using a blowtorch is to be prohibited. This may

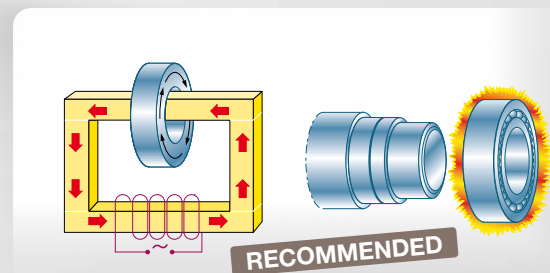

What the NTN-SNR experts have to say:

The temperature should not be too high so as not to modify the characteristics of the steel (maximum +130°C) or of the internal components of the bearing.

On the other hand, the temperature must be high enough to generate sufficient expansion for the easy installation of the bearing through temporarily loosening the fit.

The heating temperature is a function, one, of the dimensions and, two, of the fit and material of the bearing seat.

Generally, the following temperatures are recommended:

Bore diameter	Heating temperature
Up to 100 mm	+90°C
100 to 150 mm	+120°C
Over 150 mm	+ 130°C

Bearings with seals should not be heated above 80°C.

Hydraulic fitting

The mounting of large bearings with tapered bores requires considerable effort that is difficult to produce by mechanical screw tightening. The use of a hydraulic technology proves necessary in such cases.

Oil is injected under high pressure to create an oil film over the whole of the contact surface between the seat and the inner ring. This reduces the friction generated by the mounting and facilitates tightening.

A hydraulic nut can be used at the same time to develop the necessary mounting force.

The two principles may be used alternatively to make mounting easier. The residual clearance is checked using feeler gauges or a comparator which measures the sink depth on the tapered seat.

2 types of assembly correspond to this method:

→ Cylindrical shaft associated to an adapter sleeve

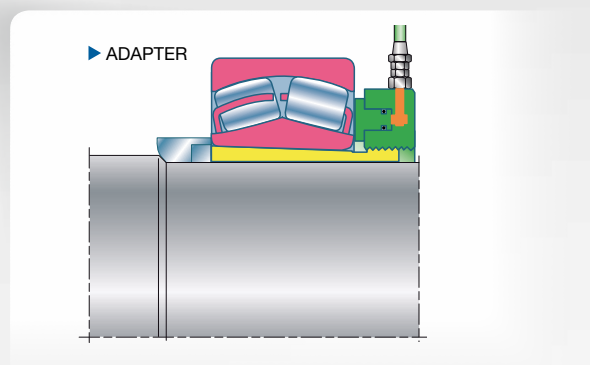

Mounting on sleeve with a hydraulic nut

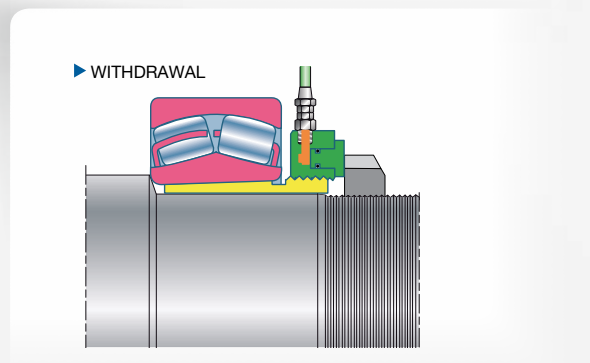

Mounting on withdrawal sleeve by indirect pushing of the hydraulic nut

Note: You could use the same hydraulic nut for assembly and disassembly

→ On tapered journal

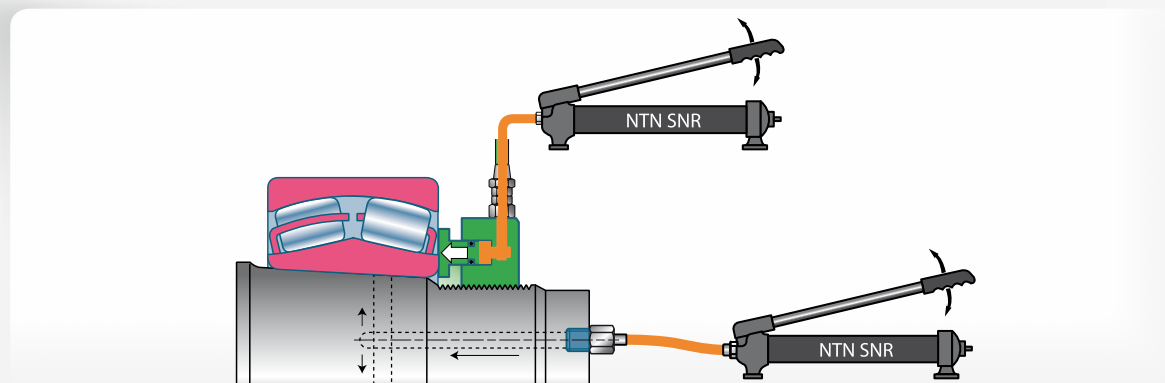

Simultaneous use of hydraulic nut associated to oil film injection

Mounting clearance

Axial clearance

Since the axial clearance J_a is a function of the radial clearance J_r , it can be calculated by means of the following approximation formula:

$$J_a = 2.27 Y_o \cdot J_r$$

Reduction of the mounting clearance

When mounting the bearing on the sleeve or on the machined tapered seat, the expansion of the inner ring reduces the internal radial clearance of the bearing. Varying the clearance allows you to appreciate the degree of tightness. It is important to check this. Ensure that the residual clearance required for the bearing to function properly is maintained.

Double-row spherical roller bearings

- Measurement principle

Ensure that the rings are perfectly aligned. Turn the bearing in order to put the rollers in place.

The clearance is measured using feeler gauges that are slid between the outer ring and the rollers. For large rollers, do not use gauges in excess of 15 hundredths of a millimetre, since they are too rigid to marry the curve of the roller raceway; instead, use a combination of thinner gauges.

- Measurement methods

Mounting on a horizontal shaft:

- ◆ Measurement of initial clearance

The measurement is carried out on two rollers of the two rows simultaneously.

Locate in the following table the standard clearance values corresponding to the bore and to the clearance class for the bearing in question (column 2 of the table) Select a feeler gauge slightly larger than the minimum clearance value (column 2). Slide it in at an angle between the rollers under no load and the raceway of the outer ring (top part of the bearing if it is in contact with a surface, or bottom part of the bearing if the outer ring remains free or suspended). Introduce gauges in ascending order of thickness. The clearance value is located between the last gauge that can penetrate and the one that fails to penetrate. This must be less than the maximum clearance value.

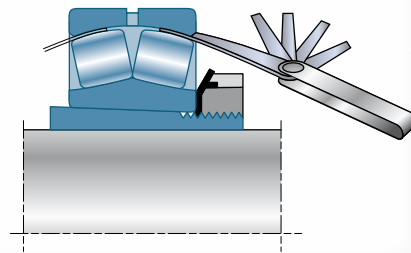

- ◆ Checking clearance reduction

→ Radial

Tighten until internal clearance reduction is obtained within the stated limits. The measurement method is identical to that described above. Check that the final residual clearance, as a function of the original clearance class, is at least equal to the stated value (column 3).

→ Axial (full shaft with tapered seat)

The axial displacement corresponding to the tightening should be within the stated limits (column 4). Next, check that the final residual clearance, as a function of the original clearance class, is at least equal to the stated value. For assemblies using an NTN-SNR hydraulic nut, the axial movement is checked by placing a comparator on the NTN-SNR hydraulic nut. An attachment mechanism is provided for this purpose. It measures the movements of the piston that pushes the inner ring of the bearing against the seat of the bearing. It is a reliable and rapid method for checking the reduction of the radial clearance.

Checking the radial clearance on assembly

Bearing bore (mm)		Before assembly						After assembly						Axial displacement			
		C0		C3		C4		C0		C3		C4		mm			
From	To	According ISO 5753 (in mm)		According ISO 5753 (in mm)		According ISO 5753 (in mm)		Feeler gauge*		Feeler gauge*		Feeler gauge*		Taper 1:12		Taper 1:30	
		Min	Max	Min	Max	Min	Max	yes	no	yes	no	yes	no	Min	Max	Min	Max
30	40	0.035	0.050	0.050	0.065	0.065	0.085	2	3	3	4	4	5	0.350	0.400	-	-
40	50	0.045	0.060	0.060	0.080	0.080	0.100	3	4	3	5	4	6	0.400	0.450	-	-
50	65	0.055	0.075	0.075	0.095	0.095	0.120	3	5	4	6	5	7	0.450	0.600	-	-
65	80	0.070	0.095	0.095	0.120	0.120	0.150	4	6	5	7	6	8	0.600	0.750	-	-
80	100	0.080	0.110	0.110	0.140	0.140	0.180	4	6	6	8	7	10	0.700	0.900	1.700	2.200
100	120	0.100	0.135	0.135	0.170	0.170	0.220	5	7	7	9	9	12	0.750	1.100	1.900	2.700
120	140	0.120	0.160	0.160	0.200	0.200	0.260	8	11	10	13	12	17	1.100	1.400	2.700	3.500
140	160	0.130	0.180	0.180	0.230	0.230	0.300	8	12	11	15	14	19	1.200	1.600	3.000	4.000
160	180	0.140	0.200	0.200	0.260	0.260	0.340	9	13	12	17	16	21	1.300	1.700	3.200	4.200
180	200	0.160	0.220	0.220	0.290	0.290	0.370	11	16	15	20	20	26	1.400	2.000	3.500	5.000
200	225	0.180	0.250	0.250	0.320	0.320	0.410	12	17	17	22	22	28	1.600	2.200	4.000	5.500
225	250	0.200	0.270	0.270	0.350	0.350	0.450	14	19	18	24	24	31	1.700	2.400	4.200	6.700
250	280	0.220	0.300	0.300	0.390	0.390	0.490	15	21	20	27	26	33	1.900	2.700	4.700	6.700
280	315	0.240	0.330	0.330	0.430	0.430	0.540	16	23	22	29	29	37	2.000	3.000	5.000	7.500
315	355	0.270	0.360	0.360	0.470	0.470	0.590	18	25	24	32	32	40	2.400	3.300	6.000	8.200
355	400	0.300	0.400	0.400	0.520	0.520	0.650	20	27	27	36	35	44	2.600	3.600	6.500	9.000
400	450	0.330	0.440	0.440	0.570	0.570	0.720	22	30	29	39	38	49	3.100	4.000	7.700	10.000
450	500	0.370	0.490	0.490	0.630	0.630	0.790	25	33	33	43	42	54	3.300	4.400	8.200	11.000
500	600	0.410	0.540	0.540	0.680	0.680	0.870	28	37	36	46	46	59	3.700	5.000	9.200	12.500

*Practical measurement of clearance per 1/100 mm using feeler gauges. The values less than 4/100 mm, use laminated shims.

Relation between the axial displacement (a) of a bearing with tapered bore and the corresponding reduction of its clearance ΔJ_r :

Taper 1/12 $a = 12 \Delta J_r / t_i$

Taper 1/30 $a = 30 \Delta J_r / t_i$

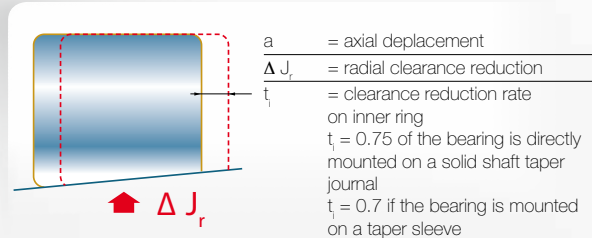

Mechanical removal

What the experts say

Take care when dismantling: look after your equipment and save time, while working safely.

Wherever possible, the bearing should be extracted by exerting force on the tightened ring.

There are various types of extractor depending on the nature of the purchase offered by the bearings, their accessibility and the extraction force required

Extractors equipped with a pump and hydraulic jack allow operators to exert powerful extraction force through muscular effort alone. These can be easily deployed by means of the self-centring arms of the devices.

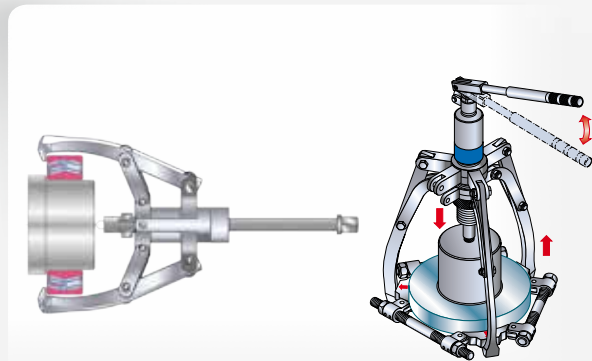

Hydraulic removal

bearing seats are equipped with distribution channels and grooves for removal by means of hydraulic pressurisation. Likewise, the NTN-SNR adapter and withdrawal sleeves are equipped with these devices for shafts of 200 mm and above.

This method is quick and reliable: it requires a high pressure pump and a maximum power of 700 bar in the case of tapered seats.

In the case of a cylindrical seat, it is necessary to maintain high pressure and accompany this with the removal of the bearing using mechanical extraction methods.

If an adapter sleeve or withdrawal sleeve was used for fitting, the hydraulic nut may be used for fast and effortless removal.

▶ HYDRAULIC REMOVAL

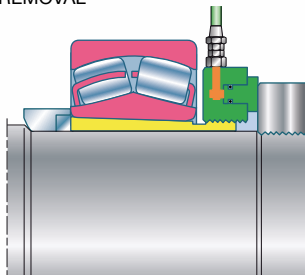

Screw the nut on the hydraulic sleeve without pressing against the bearing. Inject oil extraction up the sleeve.



Extraction of the adapter sleeve with a hydraulic nut

▶ HYDRAULIC REMOVAL

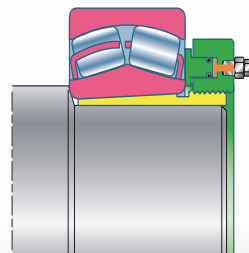

Screw the hydraulic nut on the sleeve removal, the piston in contact with the bearing. Inject oil extraction up the sleeve.



Extraction of the withdrawal sleeve with a hydraulic nut

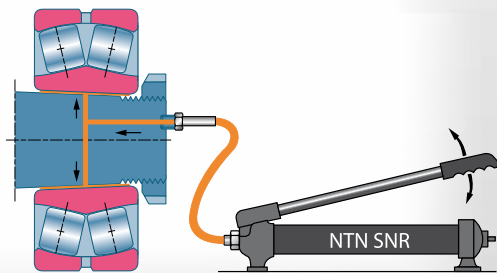

Principle of removing hydraulic oil injection channels.



Hydraulic removal





Part 5

Technical data for bearings

• General information	52
• Designation of bearings: prefixes, suffixes	55
• List of double-row spherical roller bearings	56
• List of adapter sleeves and withdrawal sleeves	72

Depending on the series and the dimensions, the double-row spherical roller bearings have different internal designs. You will find below a list of all the possible variants from NTN-SNR.

General information

Design

- Depending on the series and the dimensions, the bearings are produced according to the following descriptions.
- E and V-type series have symmetrical rollers.
- B-type series have asymmetrical rollers.

V-type

Two open steel plate cages centred on the rollers. No central shoulder section or guide ring. Lateral retaining shoulder sections.

VM-type

Solid one-piece brass cage centred on the rollers for the 213xx series, centred on the inner ring for the other series. Lateral retaining shoulder sections.

EA-type

Two steel plate cages with window centred on the inner ring. No central shoulder section or guide ring.

EM-type

Solid one-piece cage centred on the rollers. No central shoulder section or guide ring. Lateral retaining shoulder sections.

EG15-type

Two polyamide cages centred on the inner ring. No central shoulder section or guide ring.

B-type

Two solid machined steel cages centred on the shoulder section of the inner ring. Lateral retaining shoulder sections.

BL1-type

Two solid machined brass cages centred on the shoulder section of the inner ring. Lateral retaining shoulder sections.

NTN-SNR ULTAGE

NTN-SNR ULTAGE bearings are indicated in the data tables by an asterisk*.

Cylindrical or tapered bore

NTN-SNR bearings are available either with cylindrical bore or tapered bore.

- Suffix K: tapered bore 1:12
- Suffix K30: tapered bore 1:30 for series 240xx, 241xx, 248xx.

Misalignment

The design of the spherical roller bearings allows for misalignment between the outer ring and the inner ring with no loss of bearing performance.

Under normal operating conditions, C/P ratio > 10, the permissible angle of tilt is 0.5°.

This angle of tilt is permissible in cases where the misalignment of the inner ring is constant with respect to the outer ring and in the case of a rotating inner ring.

This value depends on the parts surrounding the bearing or on the type of external seal used.





In the case of a rotating outer ring or variable misalignment, the permissible angle of tilt is reduced. In the case of low loads, the angle of tilt may reach 2°. For these particular cases, please contact your NTN-SNR representative.

Lubrication groove and holes

With the exception of the 213xx series, all the bearings have a groove and holes for lubrication. For the number of lubrication holes, see the data table.

- Suffix W33 for type V or E bearings
- Suffix D1 for type B bearings (Asian market specification).

Guidance in the choice of cages

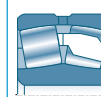
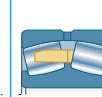
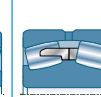
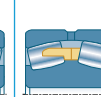
		Guided steel cage on rollers	Guided solid machined steel cage on rollers	Guided machined brass solid cage on rollers	Guided steel cage on inner ring	Guided machined brass solid cage on rollers	Guided polyamide cage on inner ring	Guided solid machined cage on inner ring	Guided solid machined steel cage on inner ring	Guided solid machined brass cage on inner ring
										
		-	-	M	A	M	G15	M	-	L1
SERIES		BORE CODE								
213..	V	up to 16	-	17 - 18	-	-	-	-	-	-
213..		-	19 to 22	-	-	-	-	-	-	-
222..	E	-	-	-	up to 32	up to 64	up to 22	-	-	-
222..	B	-	-	-	-	-	-	-	56 to 64	56 to 64
223..	E	-	-	-	up to 28	up to 60	up to 16	-	-	-
223..	E (F800)	-	-	-	-	up to 34	-	-	-	-
223..	B	-	-	-	-	-	-	-	60	-
230..	E	-	-	-	up to 38	22 to 88	-	-	-	-
230..	B	-	-	-	-	-	-	-	from to 84	from to 84
231..	E	-	-	-	up to 36	up to 80	-	-	-	-
231..	B	-	-	-	-	-	-	-	from to 76	from to 76
232..	E	-	-	-	up to 32	up to 72	-	-	-	-
232..	B	-	-	-	-	-	-	-	from to 64	to parir to 64
238..		-	-	-	-	-	-	-	from to 56	-
239..	E	-	-	-	-	up to 56	-	-	-	-
239..		-	-	-	-	-	-	-	from to 60	from to 60
240..	E	-	-	-	up to 36	38 to 60	-	44	-	-
240..	V	-	-	-	-	-	-	52 - 60	-	-
240..	B	-	-	-	-	-	-	-	from to 64	from to 64
241..	E	-	-	-	up to 38	40 to 44	-	-	-	-
241..	V	-	-	-	-	-	-	48 to 60 - 68	-	-
241..	B	-	-	-	-	-	-	-	from to 64	from to 64
248..		-	-	-	-	-	-	-	64 to 92	from to 1500

Tolerances

NTN-SNR bearings are delivered with normal precision according to standard ISO 492. The EF800 series has special tolerances on the outer diameter and bore that are suited to high-vibration applications on account of their interchangeability. On request, NTN-SNR can supply bearings with reduced tolerances for one or more characteristics (bore, outer diameter, rotation, precision of the inner ring, etc.).

Internal radial clearance

The radial clearance is defined by standard ISO 5753. See tables below.

NTN-SNR bearings are manufactured as standard with a Normal internal radial clearance. Most product references are available with C3 or C4 clearance. Clearances less than Normal C2 or greater than C5 may also be supplied on request. Please contact your NTN-SNR representative to check for availability.

Radial clearance of spherical roller bearing with taper bore

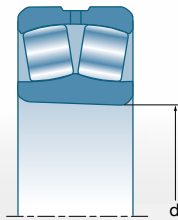

Bore diameter		Internal radial clearance									
d.		C2		Normal		C3		C4		C5	
over	ind	min	max	min	max	min	max	min	max	min	max
mm		μm									
24	30	20	30	30	40	40	55	55	75	-	-
30	40	25	35	35	50	50	65	65	85	85	105
40	50	30	45	45	60	60	80	80	100	100	130
50	65	40	55	55	75	75	95	95	120	120	160
65	80	50	70	70	95	95	120	120	150	150	200
80	100	55	80	80	110	110	140	140	180	180	230
100	120	65	100	100	135	135	170	170	220	220	280
120	140	80	120	120	160	160	200	200	260	260	330
140	160	90	130	130	180	180	230	230	300	300	330
160	180	100	140	140	200	200	260	260	340	340	430
180	200	110	160	160	220	220	290	290	370	370	470
200	225	120	180	180	250	250	320	320	410	410	520
225	250	140	200	200	270	270	350	350	450	450	570
250	280	150	220	220	300	300	390	390	490	490	620
280	315	170	240	240	330	330	430	430	540	540	680
315	355	190	270	270	360	360	470	470	590	590	740
355	400	210	300	300	400	400	520	520	650	650	820
400	450	230	330	330	440	440	570	570	720	720	910
450	500	260	370	370	490	490	630	630	790	790	1 000
500	560	290	410	410	540	540	580	680	870	870	1 100
560	630	320	460	460	600	600	760	760	930	960	1 230
630	710	350	510	510	670	670	850	850	1 090	1 090	1 360
710	800	390	570	570	750	750	960	960	1 220	1 220	1 500
800	900	440	640	640	840	840	1 070	1 070	1 370	1 370	1 600
900	1 000	490	710	710	930	930	1 190	1 190	1 520	1 520	1 860
1 000	1 120	530	770	770	1 030	1 030	1 300	1 300	1 670	1 670	2 050
1 120	1 250	570	830	830	1 120	1 120	1 420	1 420	1 830	1 830	2 250
1 250	1 400	620	910	1 230	1 230	1 560	1 560	1 560	2 000	2 000	2 450
1 400	1 600	630	1 000	1 000	1 350	1 350	1 720	1 720	2 200	2 200	2 700
1 600	1 800	750	1 110	1 110	1 500	1 500	1 920	1 920	2 400	2 400	2 950

Radial clearance of spherical roller bearing with cylindrical bore

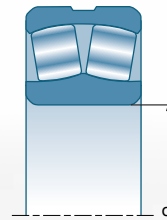

Bore diameter		Internal radial clearance									
d.		C2		Normal		C3		C4		C5	
over	ind	min	max	min	max	min	max	min	max	min	max
mm		μm									
18	24	10	20	20	35	35	45	45	60	60	75
24	30	15	25	25	40	40	55	55	75	75	95
30	40	15	30	30	45	45	60	60	80	80	100
40	50	20	35	35	55	55	75	75	100	100	125
50	65	20	40	40	65	65	90	90	120	120	150
65	80	30	50	50	80	80	110	110	145	145	185
80	100	35	60	60	100	100	135	135	180	180	225
100	120	0	75	75	120	120	160	160	210	210	260
120	140	50	95	95	145	145	190	190	240	240	300
140	160	60	110	110	170	170	220	220	280	280	350
160	180	65	120	120	180	180	240	240	310	310	390
160	200	70	130	130	200	200	260	260	340	340	430
200	225	80	140	140	220	220	290	290	380	380	470
225	250	90	150	150	240	240	320	320	420	420	520
250	280	100	170	170	260	260	350	350	460	460	570
280	315	110	190	190	280	280	370	370	500	500	630
315	355	120	200	200	310	310	410	410	550	550	690
355	400	130	220	220	340	340	450	450	600	600	750
400	450	140	240	240	370	370	500	500	660	660	820
450	500	140	260	260	410	410	550	550	720	720	900
500	560	150	280	280	440	440	600	600	780	780	1 000
560	630	170	310	310	450	450	650	650	850	850	1 100
630	710	190	350	350	530	530	700	700	920	920	1 190
710	800	210	390	390	580	580	770	770	1 010	1 010	1 300
800	900	230	430	430	650	650	860	860	1 120	1 120	1 440
900	1 000	260	450	450	710	710	930	930	1 220	1 220	1 570
1 000	1 120	290	530	530	780	780	1 020	1 020	1 330	1 330	1 720
1 120	1 250	320	580	580	860	860	1 120	1 120	1 450	1 450	1 870
1 250	1 400	350	640	640	950	950	1 240	1 240	1 620	1 620	2 050
1 400	1 600	400	720	720	1 060	1 060	1 380	1 380	1 800	1 800	2 300
1 600	1 800	450	810	810	1 180	1 180	1 550	1 550	2 000	2 000	2 550

Designation of bearings: suffixes, prefixes

Prefixes

E	Case-hardening steel
6E	Case-hardened inner ring
TSx	Temperature-stabilised version (up to +250°C)
WA	NTN origin LLS sealed version
10X	Non-ISO ring diameter for NTN origin EE sealed version

Suffixes

A	Two steel plate cages with window centred on the inner ring
B	Optimised internal design, asymmetrical rollers
C2	Internal radial clearance less than normal
C3	Internal radial clearance greater than normal
C4	Internal radial clearance greater than C3
C5	Internal radial clearance greater than C4
E	Increased capacity design, symmetrical rollers
EE	Reinforced seal properties (NBR) on both sides of the bearing. 30% grease-filled with high-pressure grease.
F800	Bearing with solid cage for high-vibration applications, special C4 clearance
F801	Bearing with solid cage for high-vibration applications, special C3 clearance
F802	Bearing with solid cage for high-vibration applications, special C0 clearance
G15	Two glass fibre-reinforced polyamide cages
K	Tapered bore, taper 1:12
K30	Tapered bore, taper 1:30
L	Modified internal design
M	One-piece solid brass cage centred on rollers
N	Groove for stop segment on outer ring
P5	ISO class 5 rotation precision
P6	ISO class 6 rotation precision
V	Optimised internal design, symmetrical rollers
W33	Groove and lubrication holes on outer ring (see data tables)
W34	Lubrication holes on inner ring
W45A	Tapped holes on one side of outer ring

Type B, NTN brand bearings

Type B bearings with an outer diameter of over 420 mm are always supplied with groove and lubrication holes without suffix.

D1	Groove and lubrication holes on outer ring (see data tables)
F1	Two solid machined carbon steel cages centred on inner ring
F3	Two solid machined steel cages centred on inner ring
L1	Two solid machined brass cages centred on inner ring
PX50	ISO class 5 rotation precision, inner and outer ring
PX51	ISO class 5 rotation precision, inner ring
PX52	ISO class 5 rotation precision, outer ring
UA	Bearing with asymmetrical rollers and solid cage centred on the outer ring for high-vibration applications

List of double-row spherical roller bearings

Overall dimensions			ULTAGE	Designations	Load limit fatigue C _u	Basic capacity		Calcul factor				Reference speed	Limit speed
d	D	B				Cylindrical bore	C	C ₀	e	Y ₁	Y ₂		
mm				kN								rpm	
25	52	18	*	22205EAW33	4.6	57.3	46.1	0.34	2	2.98	1.96	13000	17000
	52	18	*	22205EG15W33	4.6	57.3	46.1	0.34	2	2.98	1.96	13000	17000
	52	18	*	22205EMW33	4.25	54.1	42.8	0.34	2	2.98	1.96	14000	17000
	62	17		21305V	5	51	37.5	0.29	2.33	3.47	2.28	8900	14000
30	62	20	*	22206EAW33	6.5	75.7	64.5	0.31	2.15	3.2	2.1	11000	14000
	62	20	*	22206EG15W33	6.5	75.7	64.5	0.31	2.15	3.2	2.1	11000	14000
	62	20	*	22206EMW33	6.1	71.9	60.2	0.31	2.15	3.2	2.1	11200	14000
	72	19		21306V	6.5	66.2	50	0.28	2.45	3.64	2.39	7800	12000
35	72	23	*	22207EAW33	8.55	100	92	0.31	2.21	3.29	2.16	9500	12000
	72	23	*	22207EG15W33	8.55	100	92	0.31	2.21	3.29	2.16	9500	12000
	72	23	*	22207EMW33	8.55	100	92	0.31	2.21	3.29	2.16	9500	12000
	80	21		21307V	8.65	83.1	66	0.27	2.48	3.69	2.42	7100	11000
40	80	23	*	22208EAW33	10.9	116	105	0.27	2.47	3.67	2.41	8100	11000
	80	23	*	22208EG15W33	10.9	116	105	0.27	2.47	3.67	2.41	8100	11000
	80	23	*	22208EMW33	10.2	110	98	0.27	2.47	3.67	2.41	8300	11000
	90	23		21308V	10.9	101	84	0.26	2.55	3.8	2.5	6400	9300
	90	33	*	22308EAW33	13.3	169	152	0.36	1.87	2.79	1.83	5800	7400
	90	33	*	22308EG15W33	13.3	169	152	0.36	1.87	2.79	1.83	5800	7400
	90	33	*	22308EMW33	13.3	169	152	0.36	1.87	2.79	1.83	5800	7400
	90	33	*	22308EF800	13.3	169	152	0.36	1.87	2.79	1.83	5800	7400
45	85	23	*	22209EAW33	12.3	121	113	0.26	2.64	3.93	2.58	7300	9800
	85	23	*	22209EG15W33	12.3	121	113	0.26	2.64	3.93	2.58	7300	9800
	85	23	*	22209EMW33	11.6	116	106	0.26	2.64	3.93	2.58	7500	9800
	100	25		21309V	13.7	125	106	0.26	2.64	3.93	2.58	5800	8400
	100	36	*	22309EAW33	16.7	206	187	0.36	1.9	2.83	1.86	5300	6700
	100	36	*	22309EG15W33	16.7	206	187	0.36	1.9	2.83	1.86	5300	6700
	100	36	*	22309EMW33	16.7	206	187	0.36	1.9	2.83	1.86	5300	6700
	100	36	*	22309EF800	16.7	206	187	0.36	1.9	2.83	1.86	5300	6700
50	90	23	*	22210EAW33	14.2	130	124	0.24	2.84	4.23	2.78	6600	9100
	90	23	*	22210EG15W33	14.2	130	124	0.24	2.84	4.23	2.78	6600	9100
	90	23	*	22210EMW33	13.4	125	117	0.24	2.84	4.23	2.78	6700	9100
	110	27		21310V	16.7	144	128	0.25	2.71	4.04	2.65	5400	7600
	110	40	*	22310EAW33	19.9	250	232	0.36	1.87	2.79	1.83	4900	6100
	110	40	*	22310EG15W33	19.9	250	232	0.36	1.87	2.79	1.83	4900	6100
	110	40	*	22310EMW33	19.9	250	232	0.36	1.87	2.79	1.83	4900	6100
	110	40	*	22310EF800	19.9	250	232	0.36	1.87	2.79	1.83	4900	6100
55	100	25	*	22211EAW33	17.6	155	148	0.23	2.95	4.4	2.89	6000	8200
	100	25	*	22211EG15W33	17.6	155	148	0.23	2.95	4.4	2.89	6000	8200
	100	25	*	22211EMW33	16.6	148	140	0.23	2.95	4.4	2.89	6100	8200
	120	29		21311V	20.4	176	158	0.24	2.82	4.2	2.76	5000	6900
	120	43	*	22311EAW33	24.7	296	274	0.36	1.87	2.79	1.83	4600	5600
	120	43	*	22311EG15W33	24.7	296	274	0.36	1.87	2.79	1.83	4600	5600
	120	43	*	22311EMW33	24.7	296	274	0.36	1.87	2.79	1.83	4600	5600
	120	43	*	22311EF800	24.7	296	274	0.36	1.87	2.79	1.83	4600	5600
60	110	28	*	22212EAW33	21.6	187	181	0.24	2.84	4.23	2.78	5600	7500
	110	28	*	22212EG15W33	21.6	187	181	0.24	2.84	4.23	2.78	5600	7500
	110	28	*	22212EMW33	20.4	179	171	0.24	2.84	4.23	2.78	5700	7500
	130	31		21312V	23.4	196	179	0.24	2.81	4.19	2.75	4700	6400
	130	46	*	22312EAW33	28.8	340	319	0.35	1.95	2.9	1.91	4300	5100
	130	46	*	22312EG15W33	28.8	340	319	0.35	1.95	2.9	1.91	4300	5100
	130	46	*	22312EMW33	28.8	340	319	0.35	1.95	2.9	1.91	4300	5100
	130	46	*	22312EF800	28.8	340	319	0.35	1.95	2.9	1.91	4300	5100
65	120	31	*	22213EAW33	25.4	226	224	0.24	2.79	4.15	2.73	5200	6900
	120	31	*	22213EG15W33	25.4	226	224	0.24	2.79	4.15	2.73	5200	6900
	120	31	*	22213EMW33	24	217	212	0.24	2.79	4.15	2.73	5300	6900
	140	33		21313V	27.9	236	215	0.23	2.91	4.33	2.84	4400	5900
	140	48	*	22313EAW33	32.9	369	343	0.33	2.06	3.06	2.01	4000	4800
	140	48	*	22313EG15W33	32.9	369	343	0.33	2.06	3.06	2.01	4000	4800
	140	48	*	22313EMW33	32.9	369	343	0.33	2.06	3.06	2.01	4000	4800
	140	48	*	22313EF800	32.9	369	343	0.33	2.06	3.06	2.01	4000	4800

Bearings available with cylindrical or tapered bore (EAK, EMK, EG15K, BK and K30 for 240xx and 241xx series). Bearing with tapered bore are generally fitted with adapter or withdrawal sleeves (refer to selection guidelines, p72). All types of clearances are available on stock or on request. Special clearances and special precisions are available on request.

*NTN-SNR ULTAGE bearing

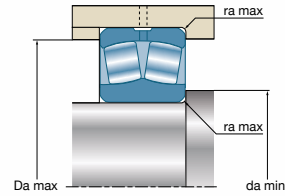
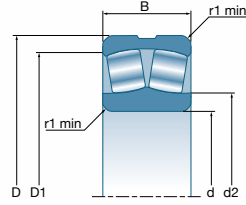
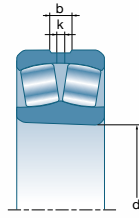

Designations	Weight	Dimensions							Fitting dimensions		
		Cylindrical bore	Number of holes	b	k	r ₁ min	d ₂	D ₁	d _a min	D _a max	r _a max
				mm							mm
22205EAW33	0.17	3	3	1.5	1	30.5	45.5	30.6	46.4	1	
22205EG15W33	0.17	3	3	1.5	1	30.5	45.5	30.6	46.4	1	
22205EMW33	0.16	3	3	1.5	1	30.5	45.5	30.6	46.4	1	
21305V	0.26	-	-	-	1.1	34.5	51.2	32	55	1	
22206EAW33	0.27	3	4.4	2	1	37.5	54.3	35.6	56.4	1	
22206EG15W33	0.27	3	4.4	2	1	37.5	54.3	35.6	56.4	1	
22206EMW33	0.28	3	4.4	2	1	37.5	54.3	35.6	56.4	1	
21306V	0.39	-	-	-	1.1	40.8	59.7	37	65	1	
22207EAW33	0.42	3	4.9	2	1.1	45.1	63	42	65	1	
22207EG15W33	0.42	3	4.9	2	1.1	45.1	63	42	65	1	
22207EMW33	0.44	3	4.9	2	1.1	45.1	63	42	65	1	
21307V	0.51	-	-	-	1.5	46.3	71	44	71	1.5	
22208EAW33	0.52	3	5.4	2.5	1.1	50.2	70.8	47	73	1	
22208EG15W33	0.51	3	5.4	2.5	1.1	50.2	70.8	47	73	1	
22208EMW33	0.50	3	5.4	2.5	1.1	50.2	70.8	47	73	1	
21308V	0.72	-	-	-	1.5	53.5	75.4	49	81	1.5	
22308EAW33	1.01	3	5.9	3	1.5	52.5	77	49	81	1.5	
22308EG15W33	1	3	5.9	3	1.5	52.5	77	49	81	1.5	
22308EMW33	1.02	3	5.9	3	1.5	52.5	77	49	81	1.5	
22308EF800	1.02	3	5.9	3	1.5	52.5	77	49	81	1.5	
22209EAW33	0.57	3	5.8	2.5	1.1	54.9	75.6	52	78	1	
22209EG15W33	0.55	3	5.8	2.5	1.1	54.9	75.6	52	78	1	
22209EMW33	0.5	3	5.8	2.5	1.1	54.9	75.6	52	78	1	
21309V	0.95	-	-	-	1.5	59.7	84.2	54	91	1.5	
22309EAW33	1.35	3	6.4	3	1.5	58	85.8	54	91	1.5	
22309EG15W33	1.33	3	6.4	3	1.5	58	85.8	54	91	1.5	
22309EMW33	1.42	3	6.4	3	1.5	58	85.8	54	91	1.5	
22309EF800	1.42	3	6.4	3	1.5	58	85.8	54	91	1.5	
22210EAW33	0.6	3	5.8	2.5	1.1	59.5	80.7	57	83	1	
22210EG15W33	0.59	3	5.8	2.5	1.1	59.5	80.7	57	83	1	
22210EMW33	0.61	3	5.8	2.5	1.1	59.5	80.7	57	83	1	
21310V	1.25	-	-	-	2	66.8	92.4	61	99	2	
22310EAW33	1.81	3	7.3	3.5	2	63.8	93.8	61	99	2	
22310EG15W33	1.78	3	7.3	3.5	2	63.8	93.8	61	99	2	
22310EMW33	1.83	3	7.3	3.5	2	63.8	93.8	61	99	2	
22310EF800	1.83	-	7.3	3.5	2	63.8	93.8	61	99	2	
22211EAW33	0.82	3	6.4	3	1.5	66	89.7	64	91	1.5	
22211EG15W33	0.82	3	6.4	3	1.5	66	89.7	64	91	1.5	
22211EMW33	0.84	3	6.4	3	1.5	66	89.7	64	91	1.5	
21311V	1.54	-	-	-	2	73.6	102	66	109	2	
22311EAW33	2.29	3	7.8	3.5	2	68.7	102.9	66	109	2	
22311EG15W33	2.24	3	7.8	3.5	2	68.7	102.9	66	109	2	
22311EMW33	2.34	3	7.8	3.5	2	68.7	102.9	66	109	2	
22311EF800	2.34	-	7.8	3.5	2	68.7	102.9	66	109	2	
22212EAW33	1.13	3	6.9	3	1.5	71.9	98.5	69	101	1.5	
22212EG15W33	1.13	3	6.9	3	1.5	71.9	98.5	69	101	1.5	
22212EMW33	1.15	3	6.9	3	1.5	71.9	98.5	69	101	1.5	
21312V	1.99	-	-	-	2.1	79.5	109.9	72	118	2	
22312EAW33	2.8	3	8.7	4	2.1	75.3	111.9	72	118	2	
22312EG15W33	2.77	3	8.7	4	2.1	75.3	111.9	72	118	2	
22312EMW33	2.89	3	8.7	4	2.1	75.3	111.9	72	118	2	
22312EF800	2.89	3	8.7	4	2.1	75.3	111.9	72	118	2	
22213EAW33	1.51	3	7.8	3.5	1.5	78.2	107	74	111	1.5	
22213EG15W33	1.51	3	7.8	3.5	1.5	78.2	107	74	111	1.5	
22213EMW33	1.56	3	7.8	3.5	1.5	78.2	107	74	111	1.5	
21313V	2.41	-	-	-	2.1	85.8	119.7	77	128	2	
22313EAW33	3.41	3	9.2	4	2.1	81.3	121.2	77	128	2	
22313EG15W33	3.35	3	9.2	4	2.1	81.3	121.2	77	128	2	
22313EMW33	3.6	3	9.2	4	2.1	81.3	121.2	77	128	2	
22313EF800	3.6	3	9.2	4	2.1	81.3	121.2	77	128	2	

List of double-row spherical roller bearings

Overall dimensions			ULTAGE	Designations	Load limit fatigue C _u	Basic capacity		Calcul factor				Reference speed	Limit speed
d	D	B				Cylindrical bore	Dynamic	Static	e	Y ₁	Y ₂		
mm				C	C ₀		rpm						
					kN								
70	125	31	*	22214EAW33	28	235	240	0.22	3.01	4.48	2.94	4800	6500
	125	31	*	22214EG15W33	28	235	240	0.22	3.01	4.48	2.94	4800	6500
	125	31	*	22214EMW33	28	235	240	0.22	3.01	4.48	2.94	4800	6500
	150	35	*	21314V	30.3	259	240	0.23	2.9	4.31	2.83	4200	5500
	150	51	*	22314EAW33	36.7	420	396	0.34	2	2.98	1.96	3800	4500
	150	51	*	22314EG15W33	36.7	420	396	0.34	2	2.98	1.96	3800	4500
	150	51	*	22314EMW33	36.7	420	396	0.34	2	2.98	1.96	3800	4500
	150	51	*	22314EF800	36.7	420	396	0.34	2	2.98	1.96	3800	4500
75	130	31	*	22215EAW33	29.5	244	249	0.22	3.14	4.67	3.07	4600	6200
	130	31	*	22215EG15W33	29.5	244	249	0.22	3.14	4.67	3.07	4600	6200
	130	31	*	22215EMW33	29.5	244	249	0.22	3.14	4.67	3.07	4600	6200
	160	37	*	21315V	34.3	295	275	0.23	2.94	4.37	2.87	4000	5200
	160	55	*	22315EAW33	42.1	491	467	0.34	2	2.98	1.96	3600	4200
	160	55	*	22315EG15W33	42.1	491	467	0.34	2	2.98	1.96	3600	4200
	160	55	*	22315EMW33	42.1	491	467	0.34	2	2.98	1.96	3600	4200
	160	55	*	22315EF800	42.1	491	467	0.34	2	2.98	1.96	3600	4200
80	140	33	*	22216EAW33	33.4	278	287	0.22	3.14	4.67	3.07	4200	5800
	140	33	*	22216EG15W33	33.4	278	287	0.22	3.14	4.67	3.07	4200	5800
	140	33	*	22216EMW33	31.6	267	272	0.22	3.14	4.67	3.07	4300	5800
	140	33	*	22216EF800	31.6	267	272	0.22	3.14	4.67	3.07	4300	5800
	170	39	*	21316V	37.6	321	305	0.23	2.95	4.4	2.89	3800	4900
	170	58	*	22316EAW33	46	541	522	0.34	2	2.98	1.96	3400	3900
	170	58	*	22316EG15W33	46	541	522	0.34	2	2.98	1.96	3400	3900
	170	58	*	22316EMW33	46	541	522	0.34	2	2.98	1.96	3400	3900
		170	58	*	22316EF800	46	541	522	0.34	2	2.98	1.96	3400
85	150	36	*	22217EAW33	37.7	324	330	0.22	3.07	4.57	3	4100	5400
	150	36	*	22217EG15W33	37.7	324	330	0.22	3.07	4.57	3	4100	5400
	150	36	*	22217EMW33	37.7	324	330	0.22	3.07	4.57	3	4100	5400
	180	41	*	21317VM	43.7	373	365	0.23	2.99	4.46	2.93	3600	4600
	180	60	*	22317EAW33	51	599	604	0.32	2.09	3.11	2.04	3200	3600
	180	60	*	22317EMW33	51	599	604	0.32	2.09	3.11	2.04	3200	3600
		180	60	*	22317EF800	51	599	604	0.32	2.09	3.11	2.04	3200
90	160	40	*	22218EAW33	42.1	384	398	0.23	2.9	4.31	2.83	3900	5100
	160	40	*	22218EG15W33	42.1	384	398	0.23	2.9	4.31	2.83	3900	5100
	160	40	*	22218EMW33	42.1	384	398	0.23	2.9	4.31	2.83	3900	5100
	160	40	*	22218EF800	42.1	384	398	0.23	2.9	4.31	2.83	3900	5100
	190	43	*	21318VM	47.5	405	400	0.23	3	4.47	2.93	3400	4600
	190	64	*	22318EAW33	56.3	668	652	0.33	2.06	3.06	2.01	3000	3500
	190	64	*	22318EMW33	56.3	668	652	0.33	2.06	3.06	2.01	3000	3500
	190	64	*	22318EF800	56.3	668	652	0.33	2.06	3.06	2.01	3000	3500
		160	52.4	*	23218EAW33	42.3	467	513	0.3	2.25	3.34	2.2	2900
	160	52.4	*	23218EMW33	42.3	467	513	0.3	2.25	3.34	2.2	2900	3700
95	170	43	*	22219EAW33	46.4	416	417	0.23	2.95	4.4	2.89	3800	4800
	170	43	*	22219EMW33	46.4	416	417	0.23	2.95	4.4	2.89	3800	4800
	200	45	*	21319	91.2	335	420	0.23	3	4.46	2.93	3300	4200
	200	67	*	22319EAW33	61.1	732	751	0.32	2.09	3.11	2.04	2800	3300
	200	67	*	22319EMW33	61.1	732	751	0.32	2.09	3.11	2.04	2800	3300
	200	67	*	22319EF800	61.1	732	751	0.32	2.09	3.11	2.04	2800	3300
100	150	50	*	24020EAW33	34.8	361	479	0.29	2.35	3.5	2.3	3000	4100
	165	52	*	23120EAW33	45.4	464	575	0.28	2.39	3.56	2.34	3200	3900
	165	52	*	23120EG15W33	45.4	464	575	0.28	2.39	3.56	2.34	3200	3900
	165	52	*	23120EMW33	45.4	464	575	0.28	2.39	3.56	2.34	3200	3900
	180	46	*	22220EAW33	51.4	472	495	0.24	2.84	4.23	2.78	3600	4600
	180	46	*	22220EG15W33	51.4	472	495	0.24	2.84	4.23	2.78	3600	4600
	180	46	*	22220EMW33	51.4	472	495	0.24	2.84	4.23	2.78	3600	4600
	180	46	*	22220EF800	51.4	472	495	0.24	2.84	4.23	2.78	3600	4600
	180	60.3	*	23220EAW33	51.3	586	661	0.31	2.18	3.24	2.13	2600	3300
	180	60.3	*	23220EMW33	51.3	586	661	0.31	2.18	3.24	2.13	2600	3300
	215	47	*	21320	59.9	370	465	0.22	3.01	4.48	2.94	3200	3900
	215	73	*	22320EAW33	70.4	827	844	0.34	1.98	2.94	1.93	2600	3100
	215	73	*	22320EMW33	70.4	827	844	0.34	1.98	2.94	1.93	2600	3100
		215	73	*	22320EF800	70.4	827	844	0.34	1.98	2.94	1.93	2600

Bearings available with cylindrical or tapered bore (EAK, EMK, EG15K, BK and K30 for 240xx and 241xx series). Bearing with tapered bore are generally fitted with adapter or withdrawal sleeves (refer to selection guidelines, p72). All types of clearances are available on stock or on request. Special clearances and special precisions are available on request.

*NTN-SNR ULTAGE bearing

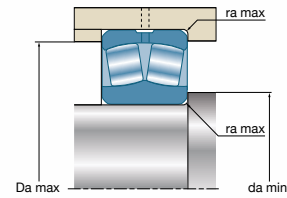
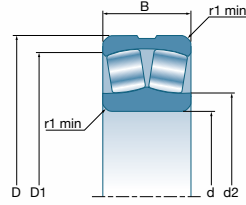
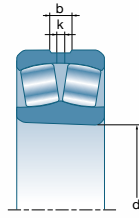

Designations	Weight	Dimensions							Fitting dimensions		
		Cylindrical bore	Number of holes	b	k	r ₁ min	d ₂	D ₁	d _a min	D _a max	r _a max
				mm							mm
22214EAW33	1.54	3	7.4	3.5	1.5	84.1	112.7	79	116	1.5	
22214EG15W33	1.52	3	7.4	3.5	1.5	84.1	112.7	79	116	1.5	
22214EMW33	1.52	3	7.4	3.5	1.5	84.1	112.7	79	116	1.5	
21314V	2.98	-	-	-	2.1	91.3	126.8	82	138	2	
22314EAW33	4.18	3	10.4	5	2.1	86	128.7	82	138	2	
22314EG15W33	4.11	3	10.4	5	2.1	86	128.7	82	138	2	
22314EMW33	4.27	3	10.4	5	2.1	86	128.7	82	138	2	
22314EF800	4.27	3	10.4	5	2.1	86	128.7	82	138	2	
22215EAW33	1.64	3	7.4	3.5	1.5	88.4	117.8	84	121	1.5	
22215EG15W33	1.62	3	7.4	3.5	1.5	88.4	117.8	84	121	1.5	
22215EMW33	1.72	3	7.4	3.5	1.5	88.4	117.8	84	121	1.5	
21315V	3.59	-	-	-	2.1	97.7	136	87	148	2	
22315EAW33	5.08	3	10.5	5	2.1	91.9	138.3	87	148	2	
22315EG15W33	5.00	3	10.5	5	2.1	91.9	138.3	87	148	2	
22315EMW33	5.21	3	10.5	5	2.1	91.9	138.3	87	148	2	
22315EF800	5.21	3	10.5	5	2.1	91.9	138.3	87	148	2	
22216EAW33	2.1	3	7.9	3.5	2	94.9	126.7	91	129	2	
22216EG15W33	2.1	3	7.9	3.5	2	94.9	126.7	91	129	2	
22216EMW33	2.1	3	7.9	3.5	2	94.9	126.7	91	129	2	
22216EF800	2.1	3	7.9	3.5	2	94.9	126.7	91	129	2	
21316V	4.2	-	-	-	2.1	104.3	144.6	92	158	2	
22316EAW33	6	3	10.5	5	2.1	98.6	147.4	92	158	2	
22316EG15W33	5.9	3	10.5	5	2.1	98.6	147.4	92	158	2	
22316EMW33	6.2	3	10.5	5	2.1	98.6	147.4	92	158	2	
22316EF800	6.2	3	10.5	5	2.1	98.6	147.4	92	158	2	
22217EAW33	2.6	3	7.9	3.5	2	100.7	136.5	96	139	2	
22217EG15W33	2.5	3	7.9	3.5	2	100.7	136.5	96	139	2	
22217EMW33	2.6	3	7.9	3.5	2	100.7	136.5	96	139	2	
21317VM	5.2	-	-	-	3	111	153.1	99	166	2.5	
22317EAW33	7.1	3	11	5	3	107.9	156.7	99	166	2.5	
22317EMW33	7.2	3	11	5	3	107.9	156.7	99	166	2.5	
22317EF800	7.2	3	11	5	3	107.9	156.7	99	166	2.5	
22218EAW33	3.3	3	10.2	4.5	2	105.3	143.2	101	149	2	
22218EG15W33	3.3	3	10.2	4.5	2	105.3	143.2	101	149	2	
22218EMW33	3.3	3	10.2	4.5	2	105.3	143.2	101	149	2	
22218EF800	3.3	3	10.2	4.5	2	105.3	143.2	101	149	2	
21318VM	6.1	-	-	-	3	117.6	161.5	104	176	2.5	
22318EAW33	8.3	3	11.6	5	3	110.1	165.1	104	176	2.5	
22318EMW33	8.5	3	11.6	5	3	110.1	165.1	104	176	2.5	
22318EF800	8.5	3	11.6	5	3	110.1	165.1	104	176	2.5	
23218EAW33	4.4	3	8.9	4	2	104.3	141	101	149	2.5	
23218EMW33	4.4	3	8.9	4	2	104.3	141	101	149	2.5	
22219EAW33	4	3	9.9	4.5	2.1	110.8	152.8	107	158	2	
22219EMW33	4.1	3	9.9	4.5	2.1	110.8	152.8	107	158	2	
21319	7.1	-	-	-	3	131.4	171	109	186	2.5	
22319EAW33	9.8	3	12.1	6	3	120	174	109	186	2.5	
22319EMW33	10.1	3	12.1	6	3	120	174	109	186	2.5	
22319EF800	10.1	3	12.1	6	3	120	174	109	186	2.5	
24020EAW33	2.9	3	6.1	2.5	1.5	111.1	135.3	107	143	1.5	
23120EAW33	4.4	3	8.4	4	2	114.6	146.9	111	154	2	
23120EG15W33	4.3	3	8.4	4	2	114.6	146.9	111	154	2	
23120EMW33	4.5	3	8.4	4	2	114.6	146.9	111	154	2	
22220EAW33	4.8	3	11.2	5	2.1	118.2	160.8	112	168	2	
22220EG15W33	4.8	3	11.2	5	2.1	118.2	160.8	112	168	2	
22220EMW33	5.1	3	11.2	5	2.1	118.2	160.8	112	168	2	
22220EF800	5.1	3	11.2	5	2.1	118.2	160.8	112	168	2	
23220EAW33	6.4	3	9.4	4.5	2.1	118.2	158.9	114	168	2	
23220EMW33	6.5	3	9.4	4.5	2.1	118.2	158.9	114	168	2	
21320	8.9	-	-	-	3	137	178.7	114	201	2.5	
22320EAW33	12.5	3	13.3	6	3	126.7	186.7	114	201	2.5	
22320EMW33	12.8	3	13.3	6	3	126.7	186.7	114	201	2.5	
22320EF800	12.8	3	13.3	6	3	126.7	186.7	114	201	2.5	

List of double-row spherical roller bearings

Overall dimensions			ULTAGE	Designations	Load limit fatigue C _u	Basic capacity		Calcul factor				Reference speed	Limit speed	
d	D	B				Cylindrical bore	C	C ₀	e	Y ₁	Y ₂			Y ₀
mm				kN								rpm		
					kN	kN								
110	170	45	*	23022EAW33	45.1	417	517	0.23	2.95	4.4	2.89	3500	4200	
	170	45	*	23022EMW33	45.1	417	517	0.23	2.95	4.4	2.89	3500	4200	
	170	60	*	24022EAW33	45.7	517	663	0.31	2.15	3.2	2.1	2800	3700	
	180	56	*	23122EAW33	50.9	547	669	0.28	2.43	3.61	2.37	3000	3500	
	180	56	*	23122EMW33	50.9	547	669	0.28	2.43	3.61	2.37	3000	3500	
	180	69	*	24122EAW33	50.8	622	769	0.36	1.85	2.76	1.81	2200	2900	
	200	53	*	22222EAW33	62.8	602	643	0.25	2.69	4	2.63	3300	4100	
	200	53	*	22222EG15W33	62.8	602	643	0.25	2.69	4	2.63	3300	4100	
	200	53	*	22222EMW33	62.8	602	643	0.25	2.69	4	2.63	3300	4100	
	200	53	*	22222EF800	62.8	602	643	0.25	2.69	4	2.63	3300	4100	
	200	69.8	*	23222EAW33	62.1	752	869	0.32	2.12	3.15	2.07	2300	3000	
	200	69.8	*	23222EMW33	62.1	752	869	0.32	2.12	3.15	2.07	2300	3000	
	240	50		21322	222	495	615	0.21	3.2	4.77	3.13	2800	3500	
	240	80	*	22322EAW33	83	975	972	0.31	2.09	3.11	2.04	2300	2800	
	240	80	*	22322EMW33	83	975	972	0.31	2.09	3.11	2.04	2300	2800	
	240	80	*	22322EF800	83	975	972	0.31	2.09	3.11	2.04	2300	2800	
120	165	34	*	23924EMD1	37.4	240	354	0.17	3.9	5.81	3.81	3300	4000	
	180	46	*	23024EAW33	50.6	446	577	0.22	3.14	4.67	3.07	3300	3900	
	180	46	*	23024EMW33	50.6	446	577	0.22	3.14	4.67	3.07	3300	3900	
	180	60	*	24024EAW33	49.3	535	705	0.3	2.28	3.39	2.23	2500	3400	
	200	62	*	23124EAW33	61.1	663	820	0.28	2.43	3.61	2.37	2600	3200	
	200	62	*	23124EMW33	61.1	663	820	0.28	2.43	3.61	2.37	2600	3200	
	200	80	*	24124EAW33	59.2	756	991	0.37	1.84	2.74	1.8	2000	2600	
	215	58	*	22224EAW33	69.6	688	753	0.25	2.74	4.08	2.68	3000	3800	
	215	58	*	22224EMW33	69.6	688	753	0.25	2.74	4.08	2.68	3000	3800	
	215	76	*	23224EAW33	70.4	857	998	0.32	2.09	3.11	2.04	2100	2800	
	215	76	*	23224EMW33	70.4	857	998	0.32	2.09	3.11	2.04	2100	2800	
	260	86	*	22324EAW33	96.2	1170	1280	0.32	2.09	3.11	2.04	2000	2500	
	260	86	*	22324EMW33	96.2	1170	1280	0.32	2.09	3.11	2.04	2000	2500	
	260	86	*	22324EF800	96.2	1170	1280	0.32	2.09	3.11	2.04	2000	2500	
130	180	37	*	23926EMD1	44.2	295	432	0.17	3.9	5.81	3.81	3100	3700	
	200	52	*	23026EAW33	61.9	565	721	0.22	3.01	4.48	2.94	3000	3600	
	200	52	*	23026EMW33	61.9	565	721	0.22	3.01	4.48	2.94	3000	3600	
	200	69	*	24026EAW33	61.2	684	909	0.31	2.18	3.24	2.13	2300	3100	
	210	64	*	23126EAW33	66.4	710	906	0.27	2.51	3.74	2.45	2400	3000	
	210	64	*	23126EMW33	66.4	710	906	0.27	2.51	3.74	2.45	2400	3000	
	210	80	*	24126EAW33	65.6	803	1080	0.34	1.96	2.92	1.92	1800	2400	
	230	64	*	22226EAW33	79	808	898	0.25	2.69	4	2.63	2700	3600	
	230	64	*	22226EMW33	79	808	898	0.25	2.69	4	2.63	2700	3600	
	230	80	*	23226EAW33	78	958	1130	0.32	2.12	3.15	2.07	1900	2600	
	230	80	*	23226EMW33	78	958	1130	0.32	2.12	3.15	2.07	1900	2600	
	280	93	*	22326EAW33	109	1330	1400	0.33	2.06	3.06	2.01	1800	2400	
	280	93	*	22326EMW33	109	1330	1400	0.33	2.06	3.06	2.01	1800	2400	
	280	93	*	22326EF800	109	1330	1400	0.33	2.06	3.06	2.01	1800	2400	
	140	190	37	*	23928EMD1	49	310	458	0.16	4.16	6.2	4.07	2900	3500
		210	53	*	23028EAW33	67	597	783	0.22	3.14	4.67	3.07	2800	3400
210		53	*	23028EMW33	67	597	783	0.22	3.14	4.67	3.07	2800	3400	
210		69	*	24028EAW33	65.3	704	958	0.28	2.39	3.56	2.34	2100	2900	
225		68	*	23128EAW33	74.9	802	1030	0.26	2.55	3.8	2.5	2200	2800	
225		68	*	23128EMW33	74.9	802	1030	0.26	2.55	3.8	2.5	2200	2800	
225		85	*	24128EAW33	74.4	951	1280	0.34	1.98	2.94	1.93	1600	2300	
250		68	*	22228EAW33	92	912	1010	0.25	2.74	4.08	2.68	2400	3300	
250		68	*	22228EMW33	92	912	1010	0.25	2.74	4.08	2.68	2400	3300	
250		88	*	23228EAW33	90.7	1140	1370	0.33	2.06	3.06	2.01	1700	2400	
250		88	*	23228EMW33	90.7	1140	1370	0.33	2.06	3.06	2.01	1700	2400	
300		102	*	22328EAW33	125	1540	1720	0.33	2.03	3.02	1.98	1600	2200	
300		102	*	22328EMW33	125	1540	1720	0.33	2.03	3.02	1.98	1600	2200	
300		102	*	22328EF800	125	1540	1720	0.33	2.03	3.02	1.98	1600	2200	
150	210	45	*	23930EMD1	58.4	419	635	0.18	3.71	5.52	3.63	2800	3200	
	225	56	*	23030EAW33	74.8	660	893	0.21	3.2	4.77	3.13	2600	3100	
	225	56	*	23030EMW33	74.8	660	893	0.21	3.2	4.77	3.13	2600	3100	
	225	75	*	24030EAW33	75.5	832	1140	0.3	2.25	3.34	2.2	1900	2700	
	250	80	*	23130EAW33	91.6	1060	1350	0.29	2.35	3.5	2.3	2000	2600	
	250	80	*	23130EMW33	91.6	1060	1350	0.29	2.35	3.5	2.3	2000	2600	
	250	100	*	24130EAW33	89.8	1120	1400	0.38	1.78	2.65	1.74	1600	2000	
	270	73	*	22230EAW33	104	1080	1220	0.25	2.74	4.08	2.68	2100	3000	
	270	73	*	22230EMW33	104	1080	1220	0.25	2.74	4.08	2.68	2100	3000	
	270	96	*	23230EAW33	105	1340	1620	0.33	2.03	3.02	1.98	1500	2200	
	270	96	*	23230EMW33	105	1340	1620	0.33	2.03	3.02	1.98	1500	2200	
	320	108	*	22330EMW33	139	1740	1890	0.34	2	2.98	1.96	1500	2100	
	320	108	*	22330EF800	139	1740	1890	0.34	2	2.98	1.96	1500	2100	

Bearings available with cylindrical or tapered bore (EAK, EMK, EG15K, BK and K30 for 240xx and 241xx series). Bearing with tapered bore are generally fitted with adapter or withdrawal sleeves (refer to selection guidelines, p72). All types of clearances are available on stock or on request. Special clearances and special precisions are available on request.

*NTN-SNR ULTAGE bearing

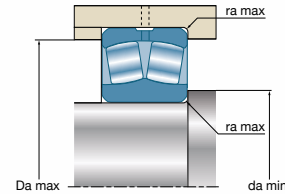
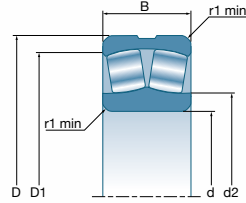
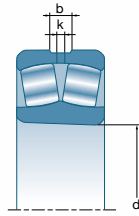

Designations	Weight	Number of holes	Dimensions					Fitting dimensions			
			Cylindrical bore	b	k	r ₁ min	d ₂	D ₁	d _a min	D _a max	r _a max
23022EAW33	3.6	3	7.8	3.5	2	123.8	154.6	119	161	2	
23022EMW33	3.6	3	7.8	3.5	2	123.8	154.6	119	161	2	
24022EAW33	5	3	7.21	3	2	120.5	151.6	119	161	2	
23122EAW33	5.5	3	8.9	4	2	125.3	160.9	121	169	2	
23122EMW33	5.5	3	8.9	4	2	125.3	160.9	121	169	2	
24122EAW33	6.7	3	8.4	4	2	121.7	157.2	121	169	2	
22222EAW33	6.9	3	12.2	6	2.1	130.1	178.4	122	188	2	
22222EG15W33	6.9	3	12.2	6	2.1	130.1	178.4	122	188	2	
22222EMW33	7.2	3	12.2	6	2.1	130.1	178.4	122	188	2	
22222EF800	7.2	3	12.2	6	2.1	130.1	178.4	122	188	2	
23222EAW33	9.3	3	10.5	5	2.1	130.2	175.8	122	188	2	
23222EMW33	9.4	3	10.5	5	2.1	130.2	175.8	122	188	2	
21322	11.2	-	-	-	3	150.2	202.7	124	226	2.5	
22322EAW33	16.9	3	15.6	7	3	138.9	208.1	124	226	2.5	
22322EMW33	17.4	3	15.6	7	3	138.9	208.1	124	226	2.5	
22322EF800	17.4	3	15.6	7	3	138.9	208.1	124	226	2.5	
23924EMD1	2.1	3	7	3	1.1	133	154	126	159	1.1	
23024EAW33	4	3	7.8	3.5	2	134	164.9	129	171	2	
23024EMW33	4	3	7.8	3.5	2	134	164.9	129	171	2	
24024EAW33	5.2	3	6.4	3.5	2	130.6	162.2	129	171	2	
23124EAW33	7.7	3	10	4.5	2	138.9	178.4	131	171	2	
23124EMW33	7.8	3	10	4.5	2	138.9	178.4	131	189	2	
24124EAW33	9.7	3	10	4.5	2	136	173	131	189	2	
22224EAW33	8.7	3	12.2	6	2.1	141.9	192.3	132	203	2	
22224EMW33	8.8	3	12.2	6	2.1	141.9	192.3	132	203	2	
23224EAW33	11.9	3	11	5	2.1	139.9	189	132	203	2	
23224EMW33	11.6	3	11	5	2.1	139.9	189	132	203	2	
22324EAW33	22.2	3	18	8	3	156.9	224	134	246	2.5	
22324EMW33	22.6	3	18	8	3	156.9	224	134	246	2.5	
22324EF800	22.6	3	18	8	3	156.9	224	134	246	2.5	
23926EMD1	2.8	3	7.9	3.5	1.5	144	168	137	173	1.5	
23026EAW33	5.8	3	8.9	4	2	146	182.6	139	191	2	
23026EMW33	5.9	3	8.9	4	2	146	182.6	139	191	2	
24026EAW33	7.5	3	8.3	4	2	143	178.6	139	191	2	
23126EAW33	8.4	3	10	4.5	2	148.5	188.3	141	199	2	
23126EMW33	8.5	3	10	4.5	2	148.5	188.3	141	199	2	
24126EAW33	10.3	3	9.5	4.5	2	146	183	141	199	2	
22226EAW33	10.8	3	13.2	6	3	151.4	205.4	144	216	2.5	
22226EMW33	10.9	3	13.2	6	3	151.4	205.4	144	216	2.5	
23226EAW33	13.6	3	11.6	5	3	150.7	202.7	144	216	2.5	
23226EMW33	13.8	3	11.6	5	3	150.7	202.7	144	216	2.5	
22326EAW33	26.9	3	18.9	9	4	164.7	243	147	263	3	
22326EMW33	27.9	3	18.9	9	4	164.7	243	147	263	3	
22326EF800	27.9	3	18.9	9	4	164.7	243	147	263	3	
23928EMD1	2.9	3	8.2	3.5	1.5	153	177	147	183	1.5	
23028EAW33	6.3	3	8.9	4	2	155.6	192.7	149	201	2	
23028EMW33	6.4	3	8.9	4	2	155.6	192.7	149	201	2	
24028EAW33	8	3	8.9	4	2	152.9	188.2	149	201	2	
23128EAW33	10.9	3	10.5	5	2.1	159.3	202	152	213	2	
23128EMW33	11.3	3	10.5	5	2.1	159.3	202	152	213	2	
24128EAW33	12.5	3	10.7	4.5	2.1	156	198	152	213	2	
22228EAW33	14	3	14.2	7	3	163.9	223.9	154	236	2.5	
22228EMW33	14.4	3	14.2	7	3	163.9	223.9	154	236	2.5	
23228EAW33	17.9	3	12.6	6	3	162.6	219.6	154	236	2.5	
23228EMW33	18.2	3	12.6	6	3	162.6	219.6	154	236	2.5	
22328EAW33	34.1	3	18.9	9	4	181.7	260.3	157	283	3	
22328EMW33	34.9	3	18.9	9	4	181.7	260.3	157	283	3	
22328EF800	34.9	3	18.9	9	4	181.7	260.3	157	283	3	
23930EMD1	4.7	3	9.5	4	2	167	195	159	201	2	
23030EAW33	7.6	3	10	4.5	2.1	168.5	206.6	161	214	2	
23030EMW33	7.8	3	10	4.5	2.1	168.5	206.6	161	214	2	
24030EAW33	10.1	3	8.9	4	2.1	162.9	202.8	161	214	2	
23130EAW33	15.7	3	12.6	6	2.1	171.9	222.4	162	238	2	
23130EMW33	15.7	3	12.6	6	2.1	171.9	222.4	162	238	2	
24130EAW33	18.8	3	10.4	5	2.1	165	218.1	162	238	2	
22230EAW33	17.8	3	15.3	7	3	177.3	241.1	164	256	2.5	
22230EMW33	18	3	15.3	7	3	177.3	241.1	164	256	2.5	
23230EAW33	23.2	3	13.7	6	3	174.6	236.6	164	256	2.5	
23230EMW33	23.5	3	13.7	6	3	174.6	236.6	164	256	2.5	
22330EMW33	42	3	19.9	9	4	201	278.3	167	303	3	
22330EF800	42	3	19.9	9	4	201	278.3	167	303	3	

List of double-row spherical roller bearings

Overall dimensions			ULTRAGE	Designations	Load limit fatigue C _u	Basic capacity		Calcul factor				Reference speed	Limit speed	
d	D	B				Cylindrical bore	C	C ₀	e	Y ₁	Y ₂			Y ₀
mm				kN								rpm		
160	220	45		*	23932EMD1	64.9	455	683	0.17	3.9	5.81	3.81	2600	3000
	220	45		23932	193	320	610	0.18	3.69	5.49	3.61	2200	2500	
	220	45		23932L1D1	193	320	610	0.18	3.69	5.49	3.61	2200	2500	
	240	60	*	23032EAW33	83.1	748	1000	0.21	3.2	4.77	3.13	2400	2900	
	240	60	*	23032EMW33	83.1	748	1000	0.21	3.2	4.77	3.13	2400	2900	
	240	80	*	24032EAW33	85.2	953	1320	0.29	2.32	3.45	2.26	1800	2600	
	270	86	*	23132EAW33	103	1220	1580	0.29	2.35	3.5	2.3	1800	2400	
	270	86	*	23132EMW33	103	1220	1580	0.29	2.35	3.5	2.3	1800	2400	
	270	109	*	24132EAW33	103	1320	1740	0.38	1.76	2.62	1.72	1400	1900	
	290	80	*	22232EAW33	117	1220	1390	0.25	2.69	4	2.63	2000	2800	
	290	80	*	22232EMW33	117	1220	1390	0.25	2.69	4	2.63	2000	2800	
	290	104	*	23232EAW33	119	1550	1890	0.33	2.03	3.02	1.98	1400	2100	
	290	104	*	23232EMW33	119	1550	1890	0.33	2.03	3.02	1.98	1400	2100	
	340	114	*	22332EMW33	154	1950	2210	0.33	2.03	3.02	1.98	1400	1900	
	340	114	*	22332EF800	154	1950	2210	0.33	2.03	3.02	1.98	1400	1900	
	170	230	45	*	23934EMD1	69.7	468	723	0.16	4.11	6.12	4.02	2400	2900
230		45		23934	165	330	650	0.17	3.91	5.83	3.83	2000	2400	
230		45		23934D1	165	330	650	0.17	3.91	5.83	3.83	2000	2400	
260		67	*	23034EAW33	96.6	914	1240	0.22	3.07	4.57	3	2200	2700	
260		67	*	23034EMW33	96.6	914	1240	0.22	3.07	4.57	3	2200	2700	
260		90	*	24034EAW33	95.5	1110	1580	0.31	2.21	3.29	2.16	1600	2400	
280		88	*	23134EAW33	109	1270	1700	0.28	2.39	3.56	2.34	1700	2300	
280		88	*	23134EMW33	109	1270	1700	0.28	2.39	3.56	2.34	1700	2300	
280		109	*	24134EAW33	110	1380	1840	0.37	1.82	2.72	1.79	1300	1800	
310		86	*	22234EMW33	133	1400	1610	0.26	2.6	3.87	2.54	1800	2700	
310		110	*	23234EMW33	134	1700	2070	0.33	2.03	3.02	1.98	1300	1900	
360		120	*	22334EMW33	170	2200	2630	0.32	2.09	3.11	2.04	1200	1800	
360		120	*	22334EF800	170	2200	2630	0.32	2.09	3.11	2.04	1200	1800	
180		250	52	*	23936EMD1	81.4	573	869	0.17	3.9	5.81	3.81	2300	2700
	250	52		23936	143	440	835	0.19	3.52	5.25	3.45	1900	2200	
	250	52		23936D1	143	440	835	0.19	3.52	5.25	3.45	1900	2200	
	250	52		23936L1	143	440	835	0.19	3.52	5.25	3.45	1900	2200	
	280	74	*	23036EAW33	110	1080	1450	0.23	2.95	4.4	2.89	2000	2500	
	280	74	*	23036EMW33	110	1080	1450	0.23	2.95	4.4	2.89	2000	2500	
	280	100	*	24036EAW33	107	1280	1830	0.33	2.03	3.02	1.98	1500	2200	
	300	96	*	23136EAW33	125	1490	1960	0.29	2.32	3.45	2.26	1600	2100	
	300	96	*	23136EMW33	125	1490	1960	0.29	2.32	3.45	2.26	1600	2100	
	300	118	*	24136EAW33	121	1550	2050	0.38	1.78	2.65	1.74	1200	1700	
	320	86	*	22236EMW33	141	1450	1660	0.25	2.74	4.08	2.68	1700	2600	
	320	112	*	23236EMW33	142	1800	2270	0.33	2.06	3.06	2.01	1200	1900	
	380	126	*	22336EMW33	185	2420	2810	0.32	2.09	3.11	2.04	1200	1800	
	190	260	52	*	23938EMD1	89.4	603	935	0.17	4.05	6.04	3.96	2100	2600
260		52		23938	117	460	890	0.18	3.81	5.67	3.73	1800	1800	
260		52		23938D1	117	460	890	0.18	3.81	5.67	3.73	1800	1800	
260		52		23938L1	117	460	890	0.18	3.81	5.67	3.73	1800	1800	
290		75	*	23038EAW33	117	1140	1570	0.22	3.01	4.48	2.94	1900	2400	
290		75	*	23038EMW33	117	1140	1570	0.22	3.01	4.48	2.94	1900	2400	
290		100	*	24038EMW33	117	1300	1800	0.31	2.15	3.2	2.1	1500	2100	
320		104	*	23138EMW33	142	1670	2250	0.29	2.32	3.45	2.26	1500	2000	
320		128	*	24138EAW33	139	1900	2710	0.38	1.76	2.62	1.72	1000	1600	
340		92	*	22238EMW33	156	1620	1870	0.25	2.74	4.08	2.68	1600	2400	
340		120	*	23238EMW33	153	1990	2480	0.33	2.03	3.02	1.98	1200	1800	
400		132	*	22338EMW33	203	2600	3110	0.32	2.12	3.15	2.07	1100	1700	
200		280	60	*	23940EMD1	102	766	1190	0.18	3.76	5.59	3.67	2000	2400
		280	60		23940VMW33	122	620	1000	0.2	3.42	5.09	3.34	1700	2000
	310	82	*	23040EMW33	132	1310	1790	0.23	2.95	4.4	2.89	1800	2300	
	310	109	*	24040EMW33	131	1510	2120	0.33	2.06	3.06	2.01	1400	2000	
	340	112	*	23140EMW33	156	1890	2510	0.3	2.25	3.34	2.2	1400	1900	
	340	140	*	24140EMW33	150	2130	2930	0.39	1.74	2.59	1.7	1000	1500	
	360	98	*	22240EMW33	173	1810	2100	0.25	2.74	4.08	2.68	1500	2300	
	360	128	*	23240EMW33	169	2250	2840	0.34	1.98	2.94	1.93	1100	1700	
	420	138	*	22340EMW33	223	2830	3530	0.31	2.15	3.2	2.1	1000	1600	

Bearings available with cylindrical or tapered bore (EAK, EMK, EG15K, BK and K30 for 240xx and 241xx series). Bearing with tapered bore are generally fitted with adapter or withdrawal sleeves (refer to selection guidelines, p72). All types of clearances are available on stock or on request. Special clearances and special precisions are available on request.

*NTN-SNR ULTRAGE bearing

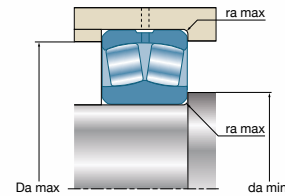
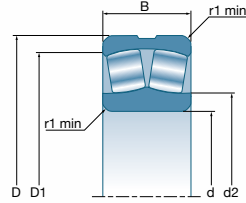
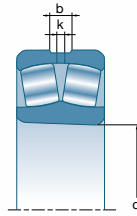

Designations	Weight	Dimensions							Fitting dimensions		
		Number of holes	b	k	r ₁ min	d ₂	D ₁	d _a min	D _a max	r _a max	
			mm							mm	
23932EMD1	4.9	3	9.5	4	2	181	201.7	170	210	2	
23932	5.5	-	-	-	2	181	201.7	170	210	2	
23932L1D1	5.5	4	7	4	2	181	201.7	170	210	2	
23032EAW33	9.2	3	10.5	5	2.1	178.5	220.2	171	229	2	
23032EMW33	9.6	3	10.5	5	2.1	178.5	220.2	171	229	2	
24032EAW33	11.8	3	9.5	4.5	2.1	173.8	216.2	171	229	2	
23132EAW33	20.1	3	13.7	6	2.1	185.7	239.8	172	258	2	
23132EMW33	20.1	3	13.7	6	2.1	185.7	239.8	172	258	2	
24132EAW33	24.8	3	11.7	5	2.1	180	234.9	172	258	2	
22232EAW33	23	3	16.9	8	3	190	258.7	174	276	2.5	
22232EMW33	23.2	3	16.9	8	3	190	258.7	174	276	2.5	
23232EAW33	29.2	3	14.9	7	3	187.1	253.7	174	276	2.5	
23232EMW33	29.6	3	14.9	7	3	187.1	253.7	174	276	2.5	
22332EMW33	50.7	3	20.3	10	4	206	295.3	177	323	3	
22332EF800	50.7	3	20.3	10	4	206	295.3	177	323	3	
23934EMD1	5.2	3	9.8	4.5	2	185	215	179	221	2	
23934	5.8	-	-	-	2	191	212	180	220	2	
23934D1	5.8	4	7	4	2	191	212	180	220	2	
23034EAW33	12.6	3	11.6	5	2.1	191.8	237.4	181	249	2	
23034EMW33	13	3	11.6	5	2.1	191.8	237.4	181	249	2	
24034EAW33	16.7	3	10.6	5	2.1	187.9	232.3	181	249	2	
23134EAW33	21.6	3	13.7	6	2.1	196.2	249.7	182	268	2	
23134EMW33	21.6	3	13.7	6	2.1	196.2	249.7	182	268	2	
24134EAW33	26	3	13.2	6	2.1	189	243.6	182	268	2	
22234EMW33	28.2	3	18	8	4	211.3	276.4	187	293	3	
23234EMW33	35.7	3	16.4	8	4	210.4	271.2	187	293	3	
22334EMW33	59	3	20.3	10	4	238.9	312.9	187	343	3	
22334EF800	59	3	20.3	10	4	238.9	312.9	187	343	3	
23936EMD1	7.5	3	10.8	5	2	199	232	189	241	2	
23936	8.2	-	-	-	2	203.5	229.9	190	240	2	
23936D1	8.2	4	9	5	2	203.5	229.9	190	240	2	
23936L1	8.2	-	-	-	2	203.5	229.9	190	240	2	
23036EAW33	16.9	3	13.2	6	2.1	203.6	255	191	269	2	
23036EMW33	16.9	3	13.2	6	2.1	203.6	255	191	269	2	
24036EAW33	21.5	3	11.7	5	2.1	202.4	249	191	269	2	
23136EAW33	27.2	3	14.9	7	3	206	266.8	194	286	2.5	
23136EMW33	27.3	3	14.9	7	3	206	266.8	194	286	2.5	
24136EAW33	33.9	3	14.1	6	3	200	260.4	194	286	2.5	
22236EMW33	28.9	3	18	8	4	220.2	286.8	197	303	3	
23236EMW33	37.8	3	16.4	8	4	220	281.2	197	303	3	
22336EMW33	70.2	3	20.9	10	4	241.8	328.2	197	363	3	
23938EMD1	7.8	3	10.8	5	2	209	243	199	251	2	
23938	8.6	-	-	-	2	214	240.3	200	250	2	
23938D1	8.6	4	9	5	2	214	240.3	200	250	2	
23938L1	8.6	-	-	-	2	214	240.3	200	250	2	
23038EAW33	17.5	3	13.2	6	2.1	213.4	265.1	201	279	2	
23038EMW33	18	3	13.2	6	2.1	213.4	265.1	201	279	2	
24038EMW33	22.5	3	11.6	5	2.1	216.2	260.1	201	279	2	
23138EMW33	33.5	3	16.55	8	3	230	283.8	204	306	2.5	
24138EAW33	42.1	3	14.16	6	3	213	277.9	204	306	2.5	
22238EMW33	35.3	3	19.6	9	4	232.8	304.8	207	323	3	
23238EMW33	48.3	3	17.5	8	4	220	298.1	207	323	3	
22338EMW33	81.6	3	20.8	10	4	247	345.6	210	380	4	
23940EMD1	11.1	3	10.8	5	2.1	221	260	211	269	2.1	
23940VMW33	12.2	3	12.2	6.3	2.1	227.2	263	211	269	2	
23040EMW33	24.1	3	14.3	7	2.1	234.9	282.3	211	299	2	
24040EMW33	29.2	3	12.7	6	2.1	229.7	276.8	211	299	2	
23140EMW33	41.7	3	17.7	8	3	242	300.6	214	326	2.5	
24140EMW33	51.3	3	17	8	3	236.8	291	214	326	2.5	
22240EMW33	42.5	3	20	10	4	245.6	322.3	217	343	3	
23240EMW33	55.8	3	18.8	9	4	244.8	314.8	217	343	3	
22340EMW33	95	3	21.1	10	5	280	363.1	220	400	4	

List of double-row spherical roller bearings

Overall dimensions			ULTRAGE	Designations	Load limit fatigue C _u	Basic capacity		Calcul factor				Reference speed	Limit speed
d	D	B				Cylindrical bore	C	C ₀	e	Y ₁	Y ₂		
mm				kN								rpm	
					kN	kN							
220	300	60	*	23944EMW33	113	741	1210	0.18	3.76	5.59	3.67	1800	2200
	340	90	*	23044EMW33	153	1530	2110	0.23	2.95	4.4	2.89	1600	2100
	340	118	*	24044EMW33	158	1930	2750	0.31	2.18	3.24	2.13	1200	1800
	370	120	*	23144EMW33	180	2190	2940	0.3	2.28	3.39	2.23	1200	1800
	370	150	*	24144EMW33	176	2600	3540	0.39	1.74	2.59	1.7	850	1400
	400	108	*	22244EMW33	208	2210	2690	0.25	2.74	4.08	2.68	1300	2000
	400	144	*	23244EMW33	207	2890	3830	0.34	2	2.98	1.96	900	1500
	460	145	*	22344VMW33	481	2110	3150	0.3	2.23	3.32	2.18	1000	1400
240	320	60	*	23948EMD1	125	815	1350	0.15	4.4	6.65	4.31	1600	2100
	360	92	*	23048EMW33	168	1630	2350	0.22	3.07	4.57	3	1400	2000
	360	118	*	24048EMW33	169	2020	3050	0.29	2.32	3.45	2.26	1100	1700
	400	128	*	23148EMW33	208	2510	3500	0.29	2.32	3.45	2.26	1100	1600
	400	160		24148VMW33	406	2270	4240	0.38	1.79	2.67	1.75	620	1300
	440	120	*	22248EMW33	228	2490	3540	0.25	2.74	4.08	2.68	1100	1800
	440	160	*	23248EMW33	233	3270	4440	0.35	1.95	2.9	1.91	800	1400
	500	155		22348VMW33	544	2450	3700	0.29	2.29	3.42	2.24	900	1300
260	360	75	*	23952EMD1	150	1130	1940	0.17	3.9	5.81	3.81	1400	1900
	400	104	*	23052EMW33	202	2060	2910	0.23	2.95	4.4	2.89	1300	1800
	400	140		24052VMW33	393	1900	3700	0.35	1.94	2.88	1.89	950	1500
	440	144	*	23152EMW33	232	2930	4350	0.3	2.25	3.34	2.2	950	1400
	440	180		24152VMW33	477	2770	5290	0.42	1.61	2.4	1.58	540	1200
	480	130		22252VMW33	509	2040	3230	0.29	2.3	3.43	2.25	1100	1300
	480	174		23252VMW33	531	2700	4450	0.33	2.06	3.07	2.02	800	1100
	540	164		22352VMW33	612	2800	4350	0.34	1.96	2.93	1.92	800	1200
280	350	52		23856	512	525	1220	0.12	5.42	8.07	5.3	-	-
	380	75	*	23956EMD1	164	1180	2050	0.16	4.16	6.2	4.07	1100	1800
	420	106	*	23056EMW33	218	2170	3150	0.22	3.07	4.57	3	1200	1700
	420	140	*	24056EMW33	219	2720	4120	0.3	2.25	3.34	2.2	900	1500
	460	146	*	23156EMW33	251	3110	4720	0.28	2.35	3.5	2.3	950	1400
	460	180		24156VMW33	510	2870	5600	0.37	1.85	2.75	1.8	540	1100
	500	130		22256B	590	2310	3800	0.26	2.57	3.83	2.51	1000	1300
	500	130		22256BL1	590	2310	3800	0.26	2.57	3.83	2.51	1000	1300
	500	176		23256VMW33	575	2900	4900	0.32	2.12	3.15	2.07	700	1100
	580	175		22356VMW33	396	3429	5182	0.31	2.17	3.24	2.12	700	1100
	300	420	90		23960	377	1110	2320	0.2	3.34	4.98	3.27	1000
420		90		23960L1	377	1110	2320	0.2	3.34	4.98	3.27	1000	1300
460		118	*	23060EMW33	243	2410	4210	0.22	3.07	4.57	3	1100	1500
460		160	*	24060EMW33	263	3400	5350	0.32	2.12	3.15	2.07	750	1300
500		160	*	23160EMW33	294	3770	5350	0.3	2.28	3.39	2.23	800	1300
500		200		24160VMW33	589	3440	6840	0.37	1.8	2.69	1.76	440	1000
540		140		22260B	354	2670	4350	0.26	2.57	3.83	2.51	900	1200
540		140		22260BL1	354	2670	4350	0.26	2.57	3.83	2.51	900	1200
540		192		23260VMW33	333	3350	5600	0.32	2.12	3.15	2.07	650	1000
620		185		22360B	446	3600	5400	0.32	2.13	3.17	2.08	670	1100
320	400	80		24864	378	870	2210	0.17	3.9	5.81	3.82	-	-
	440	90		23964	390	1140	2460	0.19	3.5	5.21	3.42	950	1300
	440	90		23964L1	390	1140	2460	0.19	3.5	5.21	3.42	950	1300
	480	121	*	23064EMW33	265	2430	4000	0.24	2.84	4.23	2.78	1000	1400
	480	160		24064B	654	2510	5200	0.33	2.06	3.07	2.02	670	1300
	480	160		24064BL1	654	2510	5200	0.33	2.06	3.07	2.02	670	1300
	540	176		23164VMW33	331	3050	5500	0.29	2.32	3.45	2.26	680	1000
	540	218		24164B	259	3850	7300	0.4	1.67	2.48	1.63	420	950
	540	218		24164BL1	259	3850	7300	0.4	1.67	2.48	1.63	420	950
	580	150		22264B	420	3100	5050	0.26	2.57	3.83	2.51	800	1100
	580	150		22264BL1	420	3100	5050	0.26	2.57	3.83	2.51	800	1100
	580	208		23264B	641	4000	7050	0.36	1.86	2.77	1.82	510	950
	580	208		23264BL1	641	4000	7050	0.36	1.86	2.77	1.82	510	950
340	460	90		23968	695	1220	2650	0.17	3.91	5.83	3.83	900	1200
	520	133		23068EMW33	254	2550	4800	0.23	2.98	4.43	2.91	900	1000
	520	180		24068B	506	3000	6200	0.34	1.98	2.95	1.94	620	1200
	520	180		24068BL1	506	3000	6200	0.34	1.98	2.95	1.94	620	1200
	580	190		23168VMW33	370	3500	6100	0.29	2.29	3.42	2.24	630	900
	580	243		24168VMW33	550	4400	8500	0.43	1.56	2.32	1.53	380	900
	620	224		23268B	493	4450	8000	0.37	1.84	2.75	1.8	470	900
	620	224		23268BL1	493	4450	8000	0.37	1.84	2.75	1.8	470	900

Bearings available with cylindrical or tapered bore (EAK, EMK, EG15K, BK and K30 for 240xx and 241xx series). Bearing with tapered bore are generally fitted with adapter or withdrawal sleeves (refer to selection guidelines, p72). All types of clearances are available on stock or on request. Special clearances and special precisions are available on request.

*NTN-SNR ULTRAGE bearing

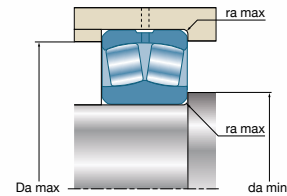
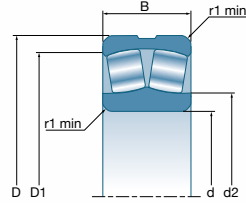
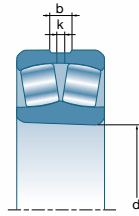

Designations	Weight	Dimensions							Fitting dimensions		
		Cylindrical bore	Number of holes	b	k	r ₁ min	d ₂	D ₁	d _a min	D _a max	r _a max
				mm							mm
23944EMW33	12.4	3	13.7	6	2.1	247.7	277.5	231	289	2	
23044EMW33	31.8	3	15.4	7	3	258.1	310	233	327	2.5	
24044EMW33	38.4	3	14.1	6	3	250.2	303.4	233	327	2.5	
23144EMW33	52.2	3	19.1	9	4	263	327.9	237	353	3	
24144EMW33	63.5	3	15.9	7	4	255.6	320.3	237	353	3	
22244EMW33	59.5	3	20.6	11	4	276.3	357.7	237	383	3	
23244EMW33	79.4	3	20	10	4	276.3	348.5	237	383	3	
22344VMW33	125	3	22.3	12	5	296	379.2	240	440	4	
23948EMD1	12.9	4	9	5	2.1	262	301	252	308	2	
23048EMW33	32.3	3	16.4	8	3	276.7	328.9	253	347	2.5	
24048EMW33	41.6	3	15.3	7	3	262	323	253	347	2.5	
23148EMW33	64.7	3	19.6	9	4	288	355.3	257	383	3	
24148VMW33	82.5	3	11.1	6	4	282	336.7	257	383	3	
22248EMW33	85	8	21.1	12	4	302	377.4	257	423	3	
23248EMW33	107	8	27	16	4	299.1	370.7	257	423	3	
22348VMW33	159	3	22.3	12	5	324	412.9	260	480	4	
23952EMD1	22.9	8	11	6	2.1	292	335	272	348	2	
23052EMW33	47.3	3	18.3	8	4	301.5	365.1	275	385	3	
24052VMW33	65	3	11.1	6	4	300	348.1	275	385	3	
23152EMW33	87.8	8	20.2	12	4	315	383	277	423	3	
24152VMW33	115	3	13.9	7.5	4	309	368.4	277	423	3	
22252VMW33	111	3	22.3	12	5	331	411	280	460	4	
23252VMW33	147	3	22.3	12	5	325.7	403.6	280	460	4	
22352VMW33	192	3	22.3	12	6	350.2	446	286	514	5	
23856	11	8	9	5	2	305	330.6	290	340	2	
23956EMD1	24	8	11	6	2.1	310	356	292	368	2	
23056EMW33	51.2	3	18.3	8	4	310	385.2	295	405	3	
24056EMW33	66	3	16.4	8	4	315.1	377.4	295	405	3	
23156EMW33	100	8	20.2	12	5	335.2	399.6	300	440	4	
24156VMW33	121	3	13.9	7.5	5	328.5	389.2	300	440	4	
22256B	112	8	20	12	5	355	434	300	480	4	
22256BL1	112	8	20	12	5	355	434	300	480	4	
23256VMW33	157	3	22.3	12	5	345.9	424.5	300	480	4	
22356VMW33	232	3	22.3	12	6	373	491.8	306	554	5	
23960	40	8	14	8	3	342	382.7	314	406	2.5	
23960L1	40	8	14	8	3	342	382.7	314	406	2.5	
23060EMW33	70.3	8	16.7	9	4	349	412.2	315	445	3	
24060EMW33	96	8	15	8	4	343	406.8	315	445	3	
23160EMW33	134	8	20.6	10	5	360.8	433.9	320	480	4	
24160VMW33	160	3	13.9	7.5	5	357	420.9	320	480	4	
22260B	141	8	20	12	5	380	468.9	320	520	4	
22260BL1	141	8	20	12	5	380	468.9	320	520	4	
23260VMW33	200	3	22.3	12	5	370.4	458.8	320	520	4	
22360B	270	8	27	16	7.5	407	521.7	336	584	6	
24864	22.8	8	11	6	2.1	348	376.5	332	388	2	
23964	43	8	14	8	3	362	403.2	334	426	2.5	
23964L1	43	8	14	8	3	362	403.2	334	426	2.5	
23064EMW33	79.6	8	19.8	10	4	381.7	440	335	465	3	
24064B	103	8	20	12	4	367	422	338	462	3	
24064BL1	103	8	20	12	4	367	422	338	462	3	
23164VMW33	175	3	22.3	12	5	387.6	466.9	340	520	4	
24164B	207	8	33	20	5	385	456.1	342	518	4	
24164BL1	207	8	33	20	5	385	456.1	342	518	4	
22264B	172	8	20	12	5	407	503.5	340	560	4	
22264BL1	172	8	20	12	5	407	503.5	340	560	4	
23264B	243	8	33	20	5	403	491.6	340	560	4	
23264BL1	243	8	33	20	5	403	491.6	340	560	4	
23968	44.7	8	14	8	3	381	423.4	354	446	2.5	
23068EMW33	100	3	22.3	12	5	396	466.5	358	502	4	
24068B	140	8	27	16	5	394	455	362	498	4	
24068BL1	140	8	27	16	5	394	455	362	498	4	
23168VMW33	209	3	22.3	12	5	412	499.9	360	560	4	
24168VMW33	266	3	17.7	9.5	5	383.9	484.7	360	560	4	
23268B	300	8	33	20	6	432	523.9	368	592	5	
23268BL1	300	8	33	20	6	432	523.9	368	592	5	

List of double-row spherical roller bearings

Overall dimensions			ULTRAGE	Designations	Load limit fatigue C _u	Basic capacity		Calcul factor				Reference speed	Limit speed
d	D	B				Cylindrical bore	C	C ₀	e	Y ₁	Y ₂		
mm				kN								rpm	
360	440	60			23872	472	735	1830	0.12	5.78	8.61	5.66	-
	480	90		23972	264	1320	2930	0.17	3.99	5.93	3.9	850	1100
	480	90		23972L1	264	1320	2930	0.17	3.99	5.93	3.9	850	1100
	540	134		23072VMW33	332	2390	4550	0.22	3.07	4.56	3	800	950
	540	180		24072B	436	3100	6600	0.33	2.06	3.07	2.02	570	1100
	540	180		24072BL1	436	3100	6600	0.33	2.06	3.07	2.02	570	1100
	600	192	*	23172EMW33	203	5190	8230	0.29	2.28	3.39	2.23	680	1000
	600	243		24172B	470	4600	9150	0.4	1.67	2.48	1.63	350	750
	600	243		24172BL1	470	4600	9150	0.4	1.67	2.48	1.63	350	750
	650	232		23272B	521	4850	8700	0.36	1.87	2.78	1.83	440	850
	650	232		23272BL1	521	4850	8700	0.36	1.87	2.78	1.83	440	850
380	520	106		23976	288	1560	3550	0.19	3.54	5.27	3.46	800	1100
	520	106		23976L1	288	1560	3550	0.19	3.54	5.27	3.46	800	1100
	560	135		23076EMW33	282	2690	5430	0.21	3.16	4.71	3.09	750	900
	560	180		24076B	402	3250	7100	0.3	2.23	3.32	2.18	530	1100
	560	180		24076BL1	402	3250	7100	0.3	2.23	3.32	2.18	530	1100
	620	194		23176B	504	3900	7500	0.31	2.16	3.22	2.12	540	900
	620	194		23176BL1	504	3900	7500	0.31	2.16	3.22	2.12	540	900
	620	243		24176B	757	4800	9650	0.39	1.73	2.58	1.69	330	750
	620	243		24176BL1	757	4800	9650	0.39	1.73	2.58	1.69	330	750
	680	240		23276B	570	5200	9650	0.36	1.89	2.82	1.85	400	800
	680	240		23276BL1	570	5200	9650	0.36	1.89	2.82	1.85	400	800
400	500	100		24880	323	1330	3500	0.18	3.76	5.59	3.67	-	-
	540	106		23980	289	1580	3650	0.18	3.71	5.53	3.63	750	1000
	540	106		23980L1	289	1580	3650	0.18	3.71	5.53	3.63	750	1000
	600	148		23080VMW33	395	2926	5648	0.22	3.08	4.59	3.02	700	850
	600	200		24080B	455	3850	8400	0.32	2.09	3.11	2.04	490	900
	600	200		24080BL1	455	3850	8400	0.32	2.09	3.11	2.04	490	900
	650	200		23180B	837	4200	8050	0.31	2.21	3.28	2.16	500	850
	650	200		23180BL1	837	4200	8050	0.31	2.21	3.28	2.16	500	850
	650	250		24180B	565	5100	10300	0.38	1.77	2.63	1.73	310	700
	650	250		24180BL1	565	5100	10300	0.38	1.77	2.63	1.73	310	700
	720	256		23280B	625	5850	10600	0.37	1.81	2.69	1.77	380	750
720	256		23280BL1	625	5850	10600	0.37	1.81	2.69	1.77	380	750	
420	520	75		23884	358	1090	2710	0.12	5.42	8.08	5.3	-	-
	560	106		23984	315	1630	3850	0.17	3.95	5.88	3.86	700	1000
	560	106		23984L1	315	1630	3850	0.17	3.95	5.88	3.86	700	1000
	620	150		23084B	505	3100	6400	0.24	2.85	4.24	2.78	650	900
	620	150		23084BL1	505	3100	6400	0.24	2.85	4.24	2.78	650	900
	620	200		24084B	505	3850	8450	0.32	2.13	3.18	2.09	470	580
	700	224		23184B	674	5200	9950	0.32	2.11	3.15	2.07	450	800
	700	280		24184B	1010	6150	12200	0.4	1.69	2.51	1.65	280	660
	700	280		24184BL1	1010	6150	12200	0.4	1.69	2.51	1.65	280	660
	760	272		23284B	786	6550	12000	0.36	1.86	2.77	1.82	350	700
440	600	118		23988	357	2030	4700	0.18	3.66	5.46	3.58	650	900
	650	157		23088B	817	3300	6850	0.24	2.85	4.24	2.78	620	850
	650	157		23088BL1	817	3300	6850	0.24	2.85	4.24	2.78	620	850
	650	212		24088B	571	4300	9450	0.32	2.11	3.15	2.07	440	850
	650	212		24088BL1	571	4300	9450	0.32	2.11	3.15	2.07	440	850
	720	226		23188B	610	5200	10100	0.31	2.15	3.21	2.11	440	800
	720	226		23188BL1	610	5200	10100	0.31	2.15	3.21	2.11	440	800
	720	280		24188B	642	6450	13100	0.39	1.75	2.61	1.71	260	640
	720	280		24188BL1	642	6450	13100	0.39	1.75	2.61	1.71	260	640
	790	280		23288B	848	6900	12800	0.36	1.88	2.8	1.84	330	690
	790	280		23288BL1	848	6900	12800	0.36	1.88	2.8	1.84	330	690
460	580	118		24892	384	1840	4850	0.18	3.76	5.59	3.67	-	-
	620	118		23992	360	2100	4950	0.17	3.95	5.88	3.86	610	900
	680	163		23092B	915	3600	7450	0.23	2.88	4.29	2.82	580	850
	680	163		23092BL1	915	3600	7450	0.23	2.88	4.29	2.82	580	850
	680	218		24092B	564	4600	10200	0.31	2.15	3.21	2.11	410	800
	760	240		23192B	795	5700	11400	0.31	2.14	3.19	2.1	400	750
	760	240		23192BL1	795	5700	11400	0.31	2.14	3.19	2.1	400	750
	760	300		24192B	827	7100	14500	0.39	1.71	2.55	1.67	240	600
	760	300		24192BL1	827	7100	14500	0.39	1.71	2.55	1.67	240	600
	830	296		23292B	807	7750	14500	0.36	1.87	2.78	1.83	300	660
	830	296		23292BL1	807	7750	14500	0.36	1.87	2.78	1.83	300	660

Bearings available with cylindrical or tapered bore (EAK, EMK, EG15K, BK and K30 for 240xx and 241xx series). Bearing with tapered bore are generally fitted with adapter or withdrawal sleeves (refer to selection guidelines, p72). All types of clearances are available on stock or on request. Special clearances and special precisions are available on request.

*NTN-SNR ULTRAGE bearing

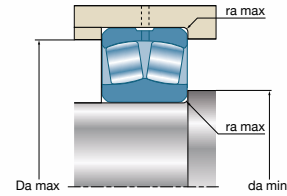
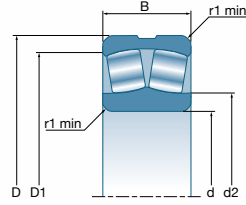
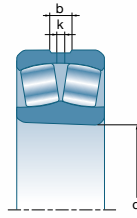

Designations	Weight	Dimensions							Fitting dimensions		
		Cylindrical bore	Number of holes	b	k	r ₁ min	d ₂	D ₁	d _a min	D _a max	r _a max
				mm							mm
23872	19.2	8	9	5	2.1	390	418.6	372	428	2	
23972	47.2	8	14	8	3	390	418.6	374	466	2.5	
23972L1	47.2	8	14	8	3	390	418.6	374	466	2.5	
23072VMW33	114	3	22.3	12	5	415	486.9	378	522	4	
24072B	147	8	27	16	5	415	476.8	382	518	4	
24072BL1	147	8	27	16	5	415	476.8	382	518	4	
23172EMW33	232	8	27	16	5	433.1	520.5	380	580	4	
24172B	281	8	33	20	5	432	506.7	382	578	4	
24172BL1	281	8	33	20	5	432	506.7	382	578	4	
23272B	339	8	33	20	6	453	551	388	622	5	
23272BL1	339	8	33	20	6	453	551	388	622	5	
23976	69.9	8	16	10	4	429	476.5	398	502	3	
23976L1	69.9	8	16	10	4	429	476.5	398	502	3	
23076EMW33	112	3	22.3	12	5	434.5	507.1	398	542	4	
24076B	153	8	27	16	5	438	498.1	402	538	4	
24076BL1	153	8	27	16	5	438	498.1	402	538	4	
23176B	235	8	27	16	5	456	539.8	402	598	4	
23176BL1	235	8	27	16	5	456	539.8	402	598	4	
24176B	292	8	33	20	5	450	528.8	402	598	4	
24176BL1	292	8	33	20	5	450	528.8	402	598	4	
23276B	380	8	33	20	6	476	574.4	408	652	5	
23276BL1	380	8	33	20	6	476	574.4	408	652	5	
24880	45.3	8	14	8	2.1	-	-	422	578	4	
23980	73	8	16	10	4	449	496.9	418	522	3	
23980L1	73	8	16	10	4	449	496.9	418	522	3	
23080VMW33	156	3	22.3	12	5	462	541	418	582	4	
24080B	202	8	27	16	5	461	527.7	422	578	4	
24080BL1	202	8	27	16	5	461	527.7	422	578	4	
23180B	264	8	27	16	6	479	567.4	428	622	5	
23180BL1	264	8	27	16	6	479	567.4	428	622	5	
24180B	329	8	33	20	6	477	551.9	428	622	5	
24180BL1	329	8	33	20	6	477	551.9	428	622	5	
23280B	457	8	33	20	6	501	611.1	428	692	5	
23280BL1	457	8	33	20	6	501	611.1	428	692	5	
23884	34.8	8	11	6	2.1	455.5	493.2	432	508	2	
23984	76.2	8	16	10	4	455.5	493.2	438	542	3	
23984L1	76.2	8	16	10	4	455.5	493.2	438	542	3	
23084B	157	8	20	12	5	488	561.4	442	598	4	
23084BL1	157	8	20	12	5	488	561.4	442	598	4	
24084B	210	8	27	16	5	481	550.1	442	598	4	
23184B	354	8	33	20	6	511	610.6	448	672	5	
24184B	440	8	33	20	6	499	592	448	672	5	
24184BL1	440	8	33	20	6	499	592	448	672	5	
23284B	544	8	33	20	7.5	528	642.7	456	724	6	
23988	101	8	16	10	4	495	550.6	458	582	3	
23088B	181	8	20	12	6	508	584.6	468	622	5	
23088BL1	181	8	20	12	6	508	584.6	468	622	5	
24088B	245	8	33	20	6	503	575.9	468	622	5	
24088BL1	245	8	33	20	6	503	575.9	468	622	5	
23188B	370	8	33	20	6	526.5	626.8	468	692	5	
23188BL1	370	8	33	20	6	526.5	626.8	468	692	5	
24188B	456	8	33	20	6	519.5	613.9	468	692	5	
24188BL1	456	8	33	20	6	519.5	613.9	468	692	5	
23288B	600	8	33	20	7.5	552	670.5	476	754	6	
23288BL1	600	8	33	20	7.5	552	670.5	476	754	6	
24892	73.6	8	16	10	3	500	542.5	474	566	2.5	
23992	107	8	16	10	4	514	571.1	478	602	3	
23092B	206	8	27	16	6	531	612	488	652	5	
23092BL1	206	8	27	16	6	531	612	488	652	5	
24092B	276	8	33	20	6	528	603.5	488	652	5	
23192B	443	8	33	20	7.5	558	659.7	496	724	6	
23192BL1	443	8	33	20	7.5	558	659.7	496	724	6	
24192B	550	8	33	20	7.5	546	644.4	496	724	6	
24192BL1	550	8	33	20	7.5	546	644.4	496	724	6	
23292B	704	8	33	20	7.5	577	702.9	496	794	6	
23292BL1	704	8	33	20	7.5	577	702.9	496	794	6	

List of double-row spherical roller bearings

Overall dimensions			ULTRAGE	Designations	Load limit fatigue C _u	Basic capacity		Calcul factor				Reference speed	Limit speed
d	D	B				Cylindrical bore	C	C ₀	e	Y ₁	Y ₂		
mm				kN			rpm						
480	650	128			23996	405	2330	5500	0.18	3.85	5.73	3.76	580
	650	128		23996L1	405	2330	5500	0.18	3.85	5.73	3.76	580	850
	700	165		23096B	987	3650	7700	0.23	2.94	4.38	2.88	560	800
	700	165		23096BL1	987	3650	7700	0.23	2.94	4.38	2.88	560	800
	700	218		24096B	983	4650	10500	0.3	2.22	3.3	2.17	400	750
	700	218		24096BL1	983	4650	10500	0.3	2.22	3.3	2.17	400	750
	790	248		23196B	886	6200	12300	0.31	2.15	3.21	2.11	380	700
	790	248		23196BL1	886	6200	12300	0.31	2.15	3.21	2.11	380	700
	790	308		24196B	889	7450	15300	0.39	1.74	2.59	1.7	350	580
	790	308		24196BL1	889	7450	15300	0.39	1.74	2.59	1.7	350	580
	870	310		23296B	1070	8300	15500	0.36	1.87	2.78	1.83	290	630
	870	310		23296BL1	1070	8300	15500	0.36	1.87	2.78	1.83	290	630
500	620	90		238/500	394	1550	3950	0.13	5.38	8.02	5.26	-	-
	670	128		239/500	548	2370	5600	0.17	4.02	5.98	3.93	560	800
	670	128		239/500L1	548	2370	5600	0.17	4.02	5.98	3.93	560	800
	720	167		230/500B	707	3850	8300	0.23	2.98	4.44	2.91	530	800
	720	167		230/500BL1	707	3850	8300	0.23	2.98	4.44	2.91	530	800
	720	218		240/500B	1070	4750	10900	0.3	2.28	3.4	2.23	380	750
	720	218		240/500BL1	1070	4750	10900	0.3	2.28	3.4	2.23	380	750
	830	264		231/500BL1	978	6950	13700	0.32	2.12	3.16	2.08	360	690
	830	325		241/500BL1	783	8050	16700	0.39	1.72	2.57	1.69	220	550
	920	336		232/500BL1	945	9400	17800	0.39	1.74	2.59	1.7	260	600
530	710	136		239/530	442	2640	6450	0.17	3.94	5.87	3.86	520	750
	710	136		239/530L1	442	2640	6450	0.17	3.94	5.87	3.86	520	750
	780	185		230/530B	649	4400	9350	0.22	3.03	4.52	2.97	490	700
	780	185		230/530BL1	649	4400	9350	0.22	3.03	4.52	2.97	490	700
	780	250		240/530B	645	5600	12700	0.3	2.24	3.33	2.19	350	690
	780	250		240/530BL1	645	5600	12700	0.3	2.24	3.33	2.19	350	690
	870	272		231/530B	838	7000	14200	0.3	2.22	3.3	2.17	340	650
	870	272		231/530BL1	838	7000	14200	0.3	2.22	3.3	2.17	340	650
	870	335		241/530B	833	8300	17400	0.38	1.79	2.67	1.75	210	530
	980	355		232/530BL1	1040	10400	19800	0.39	1.74	2.59	1.7	240	560
560	680	90		238/560	481	1650	4450	0.11	5.97	8.88	5.83	-	-
	750	140		239/560	723	2830	6700	0.16	4.09	6.09	4	490	750
	820	195		230/560B	817	4800	10500	0.22	3.03	4.51	2.96	460	690
	820	195		230/560BL1	817	4800	10500	0.22	3.03	4.51	2.96	460	690
	820	258		240/560B	730	6100	14100	0.3	2.29	3.4	2.24	320	650
	920	280		231/560B	873	7650	15500	0.3	2.27	3.38	2.22	310	620
	920	355		241/560B	1270	9950	20800	0.39	1.75	2.61	1.71	180	500
	1030	365		232/560B	1130	11100	21100	0.36	1.88	2.8	1.84	230	530
600	800	150		239/600L1	537	3150	7800	0.18	3.85	5.73	3.76	450	690
	870	200		230/600B	831	5250	12000	0.21	3.17	4.72	3.1	410	640
	870	200		230/600BL1	831	5250	12000	0.21	3.17	4.72	3.1	410	640
	870	272		240/600BL1	721	6450	15600	0.29	2.33	3.47	2.28	300	610
	980	300		231/600B	1050	9000	18400	0.3	2.22	3.3	2.17	280	580
	980	375		241/600BL1	1040	10700	23200	0.37	1.81	2.7	1.77	170	470
	1090	388		232/600B	720	12200	23700	0.36	1.86	2.77	1.82	210	500
630	780	150		248/630	673	3050	8800	0.17	4.07	6.06	3.98	-	-
	850	165		239/630	617	3700	9250	0.18	3.66	5.45	3.58	420	650
	850	165		239/630L1	617	3700	9250	0.18	3.66	5.45	3.58	420	650
	920	212		230/630B	881	5900	13000	0.22	3.14	4.67	3.07	390	610
	920	290		240/630B	857	7550	17900	0.3	2.28	3.4	2.23	270	580
	1030	315		231/630B	1050	9600	19900	0.3	2.27	3.38	2.22	260	550
	1030	400		241/630B	1120	11600	25000	0.38	1.78	2.66	1.74	160	440
1150	412		232/630B	1330	13700	26800	0.36	1.87	2.78	1.83	190	480	
670	900	170		239/670	850	4100	10300	0.18	3.76	5.59	3.67	330	530
	980	230		230/670B	976	6550	14600	0.22	3.07	4.57	3	320	500
	980	308		240/670B	1020	8650	20600	0.29	2.29	3.41	2.24	220	480
	1090	336		231/670B	1330	11000	22800	0.3	2.22	3.3	2.17	220	460
	1090	412		241/670BL1	1300	12700	28000	0.37	1.83	2.73	1.79	130	370
	1220	438		232/670B	1480	16100	32000	0.36	1.89	2.81	1.85	160	400

Bearings available with cylindrical or tapered bore (EAK, EMK, EG15K, BK and K30 for 240xx and 241xx series). Bearing with tapered bore are generally fitted with adapter or withdrawal sleeves (refer to selection guidelines, p72). All types of clearances are available on stock or on request. Special clearances and special precisions are available on request.

*NTN-SNR ULTRAGE bearing

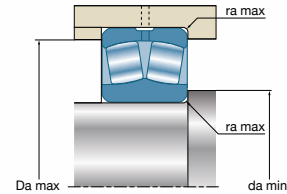
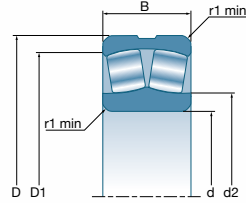
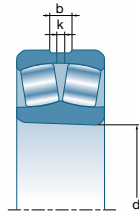

Designations	Weight	Number of holes	Dimensions						Fitting dimensions			
			Cylindrical bore	kg	b	k	r ₁ min	d ₂	D ₁	d _a min	D _a max	r _a max
23996	23996	8	20	12	5	538	598	502	628	4		
23996L1	23996L1	8	20	12	5	538	598	502	628	4		
23096B	23096B	8	27	16	6	551	632.2	508	672	5		
23096BL1	23096BL1	8	27	16	6	551	632.2	508	672	5		
24096B	24096B	8	33	20	6	547	624.7	508	672	5		
24096BL1	24096BL1	8	33	20	6	547	624.7	508	672	5		
23196B	23196B	8	33	20	7.5	579	687	516	754	6		
23196BL1	23196BL1	8	33	20	7.5	579	687	516	754	6		
24196B	24196B	8	33	20	7.5	570	670.7	516	754	6		
24196BL1	24196BL1	8	33	20	7.5	570	670.7	516	754	6		
23296B	23296B	8	33	20	7.5	605	736	516	834	6		
23296BL1	23296BL1	8	33	20	7.5	605	736	516	834	6		
238/500	238/500	8	14	8	3	542.5	588.2	514	606	2.5		
239/500	239/500	8	20	12	5	561	620.5	522	648	4		
239/500L1	239/500L1	8	20	12	5	561	620.5	522	648	4		
230/500B	230/500B	8	27	16	6	561	620.5	528	692	5		
230/500BL1	230/500BL1	8	27	16	6	561	620.5	528	692	5		
240/500B	240/500B	8	33	20	6	568	645.8	528	692	5		
240/500BL1	240/500BL1	8	33	20	6	568	645.8	528	692	5		
231/500BL1	231/500BL1	8	33	20	7.5	607	723	536	794	6		
241/500BL1	241/500BL1	8	42	25	7.5	602	702.5	536	794	6		
232/500BL1	232/500BL1	8	42	25	7.5	635	772.8	536	884	6		
239/530	239/530	8	20	12	5	590	653.6	552	688	4		
239/530L1	239/530L1	8	20	12	5	590	653.6	552	688	4		
230/530B	230/530B	8	27	16	6	614	704	558	752	5		
230/530BL1	230/530BL1	8	27	16	6	614	704	558	752	5		
240/530B	240/530B	8	33	20	6	605.5	688.4	558	752	5		
240/530BL1	240/530BL1	8	33	20	6	605.5	688.4	558	752	5		
231/530B	231/530B	8	33	20	7.5	643	757	566	834	6		
231/530BL1	231/530BL1	8	33	20	7.5	643	757	566	834	6		
241/530B	241/530B	8	42	25	7.5	630.5	736.2	566	834	6		
232/530BL1	232/530BL1	8	42	25	9.5	678	826.7	574	936	8		
238/560	238/560	8	11	6	3	599	646.9	574	666	2.5		
239/560	239/560	8	20	12	5	625	691.5	582	728	4		
230/560B	230/560B	8	27	16	6	648	740.6	588	792	5		
230/560BL1	230/560BL1	8	27	16	6	648	740.6	588	792	5		
240/560B	240/560B	8	33	20	6	639.5	725.9	588	792	5		
231/560B	231/560B	8	33	20	7.5	678.5	800.8	596	884	6		
241/560B	241/560B	8	42	25	7.5	666	786.4	596	884	6		
232/560B	232/560B	12	42	25	9.5	713	867	604	986	8		
239/600L1	239/600L1	8	20	12	5	667	738.5	622	778	4		
230/600B	230/600B	8	27	16	6	690	784.8	628	842	5		
230/600BL1	230/600BL1	8	27	16	6	690	784.8	628	842	5		
240/600BL1	240/600BL1	8	33	20	6	682	769.7	628	842	5		
231/600B	231/600B	8	33	20	7.5	720	859.5	636	944	6		
241/600BL1	241/600BL1	8	42	25	7.5	713.5	832.3	636	944	6		
232/600B	232/600B	12	42	25	9.5	-	-	644	1046	8		
248/630	248/630	8	20	12	4	-	-	648	762	3		
239/630	239/630	8	27	16	6	705	780.4	658	822	5		
239/630L1	239/630L1	8	27	16	6	705	780.4	658	822	5		
230/630B	230/630B	8	33	20	7.5	728	833.3	666	884	6		
240/630B	240/630B	8	33	20	7.5	719	814.3	666	884	6		
231/630B	231/630B	12	33	20	7.5	764	898.8	666	994	6		
241/630B	241/630B	12	42	25	7.5	748	871.5	666	994	6		
232/630B	232/630B	12	42	25	12	799.5	968.8	684	1096	10		
239/670	239/670	8	27	16	6	751	829.4	698	872	5		
230/670B	230/670B	8	33	20	7.5	775	885.5	706	944	6		
240/670B	240/670B	8	33	20	7.5	-	-	706	944	6		
231/670B	231/670B	12	42	25	7.5	-	-	706	1054	6		
241/670BL1	241/670BL1	12	42	25	7.5	795	925.3	706	1054	6		
232/670B	232/670B	12	42	25	12	849	1033.8	724	1166	10		

List of double-row spherical roller bearings

Overall dimensions			ULTRAGE	Designations	Load limit fatigue C_u	Basic capacity		Calcul factor				Reference speed	Limit speed
d	D	B				Cylindrical bore	C_u kN	Dynamic	Static	e	Y_1		
mm				C	C_0			rpm					
					kN								
710	950	180		239/710L1	752	4450	11500	0.18	3.85	5.73	3.76	360	580
	1030	236		230/710B	1110	7200	16200	0.22	3.02	4.5	2.96	340	540
	1030	236		230/710BL1	1110	7200	16200	0.22	3.02	4.5	2.96	340	540
	1030	315		240/710B	1150	9300	22500	0.29	2.36	3.51	2.31	230	520
	1030	315		240/710BL1	1150	9300	22500	0.29	2.36	3.51	2.31	230	520
	1150	345		231/710B	1360	11600	24900	0.29	2.32	3.45	2.27	220	490
	1150	438		241/710BL1	946	14500	32000	0.37	1.8	2.69	1.76	130	400
	1280	450		232/710BL1	926	16300	32500	0.35	1.91	2.84	1.87	160	430
750	920	128		238/750	883	3100	8450	0.12	5.72	8.51	5.59	-	-
	1000	185		239/750L1	1050	5000	13000	0.17	3.9	5.81	3.81	330	550
	1090	250		230/750B	1240	8150	18300	0.21	3.2	4.76	3.13	310	510
	1090	250		230/750BL1	1240	8150	18300	0.21	3.2	4.76	3.13	310	510
	1090	335		240/750BL1	1270	10100	24600	0.29	2.35	3.49	2.29	210	490
	1220	365		231/750B	870	12800	27200	0.29	2.32	3.45	2.27	210	420
	1360	475		232/750B	1690	18200	36500	0.35	1.92	2.86	1.88	150	400
800	1060	195		239/800	1080	5400	13700	0.17	4.05	6.04	3.96	310	520
	1150	258		230/800B	1320	8400	19500	0.21	3.15	4.69	3.08	290	490
	1150	345		240/800BL1	1370	11200	27800	0.28	2.41	3.59	2.36	190	460
	1280	375		231/800B	1640	14400	31000	0.29	2.32	3.45	2.27	180	400
850	1120	200		239/850	1250	5850	15100	0.16	4.25	6.32	4.15	280	490
	1120	200		239/850L1	1250	5850	15100	0.16	4.25	6.32	4.15	280	490
	1220	272		230/850BL1	1480	9750	22700	0.2	3.32	4.95	3.25	260	420
	1220	365		240/850B	1560	12500	31500	0.28	2.42	3.61	2.37	170	480
	1360	400		231/850B	1060	15500	34000	0.28	2.37	3.54	2.32	170	380
	1500	515		232/850B	2090	22300	47500	0.35	1.94	2.89	1.90	120	360
900	1180	206		239/900L1	1270	6650	17300	0.16	4.32	6.44	4.23	260	460
	1280	280		230/900B	1590	10300	24700	0.2	3.32	4.95	3.25	240	390
	1280	375		240/900B	1600	13200	33500	0.27	2.48	3.7	2.43	160	460
	1420	412		231/900B	1930	16800	38000	0.28	2.42	3.6	2.36	160	360
950	1250	224		239/950	1470	7750	20500	0.16	4.2	6.26	4.11	240	440
	1360	300		230/950B	1830	11500	28400	0.21	3.26	4.85	3.18	220	370
	1360	412		240/950B	1860	15500	40000	0.28	2.39	3.56	2.34	150	430
1000	1320	236		239/1000L1	1560	8600	22700	0.16	4.21	6.26	4.11	220	410
	1420	308		230/1000B	1120	12400	30000	0.2	3.37	5.02	3.29	210	360
	1420	412		240/1000B	1930	16000	42000	0.27	2.51	3.73	2.45	140	410
1060	1400	250		239/1060	1780	9300	24700	0.16	4.28	6.37	4.19	210	390
	1500	325		230/1060BL1	1230	13600	33500	0.2	3.36	5	3.28	200	340
	1500	438		240/1060B	2170	17800	47000	0.27	2.49	3.71	2.44	130	390
1120	1360	180		238/1120	1570	6200	18700	0.11	5.97	8.89	5.84	-	-
	1460	250		239/1120	1120	9850	26700	0.15	4.42	6.58	4.32	190	370
	1580	345		230/1120B	2350	15600	39000	0.21	3.29	4.8	3.21	180	320
	1580	462		240/1120BL1	2300	19500	52500	0.27	2.5	3.72	2.44	120	370
1180	1420	180		238/1180L1	1730	6350	19700	0.11	6.27	9.34	6.13	-	-
	1540	272		239/1180	3480	11000	29800	0.15	4.4	6.55	4.3	180	350
	1540	355		249/1180	2090	13700	40500	0.21	3.28	4.88	3.21	-	-
	1660	475		240/1180B	1020	20700	55500	0.27	2.54	3.78	2.48	110	350
1250	1630	280		239/1250	1380	12100	33500	0.15	4.42	6.58	4.32	160	330
1320	1720	300		239/1320	1470	13600	38000	0.16	4.34	6.46	4.24	150	320
	1850	530		240/1320B	3560	25200	67500	0.25	2.65	3.94	2.59	100	320
1400	1820	315		239/1400	3260	15100	43000	0.15	4.39	6.54	4.29	140	300
1500	1820	315		248/1500L1	2870	12300	41500	0.15	4.54	6.75	4.43	-	-
1800	2180	375		248/1800L1	3620	17500	60500	0.15	4.47	6.65	4.37	-	-

Bearings available with cylindrical or tapered bore (EAK, EMK, EG15K, BK and K30 for 240xx and 241xx series). Bearing with tapered bore are generally fitted with adapter or withdrawal sleeves (refer to selection guidelines, p72). All types of clearances are available on stock or on request. Special clearances and special precisions are available on request.

*NTN-SNR ULTRAGE bearing

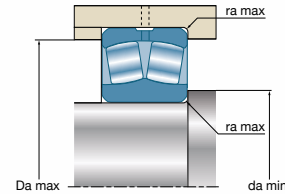
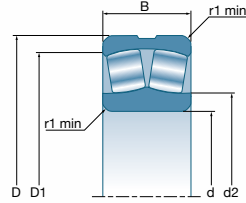
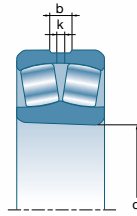

Designations	Weight	Dimensions							Fitting dimensions		
		Cylindrical bore	Number of holes	b	k	r ₁ min	d ₂	D ₁	d _a min	D _a max	r _a max
				mm							mm
239/710L1	375	8	27	16	6	795	875.3	738	922	5	
230/710B	663	12	33	20	7.5	818	936.1	746	994	6	
230/710BL1	663	12	33	20	7.5	818	936.1	746	994	6	
240/710B	884	12	33	20	7.5	808	915.7	746	994	6	
240/710BL1	884	12	33	20	7.5	808	915.7	746	994	6	
231/710B	1420	12	42	25	9.5	856	1004.8	754	1106	8	
241/710BL1	1800	12	42	25	9.5	838	978.3	754	1106	8	
232/710BL1	2540	12	42	25	12	-	-	764	1226	10	
238/750	179	8	20	12	5	809	876	772	898	4	
239/750L1	412	8	27	16	6	837.5	923.3	778	972	5	
230/750B	790	12	33	20	7.5	863	990.9	786	1054	6	
230/750BL1	790	12	33	20	7.5	863	990.9	786	1054	6	
240/750BL1	1060	12	42	25	7.5	850	968.1	786	1054	6	
231/750B	1700	12	42	25	9.5	-	-	794	1176	8	
232/750B	3050	12	42	25	15	-	-	814	1296	12	
239/800	487	12	27	16	6	889	982.5	828	1032	5	
230/800B	890	12	33	20	7.5	914	1048.6	836	1114	6	
240/800BL1	1190	12	42	25	7.5	909	1025.9	836	1114	6	
231/800B	1890	12	42	25	9.5	952	1121.3	844	1236	8	
239/850	550	12	27	16	6	947	1042.3	878	1092	5	
239/850L1	550	12	27	16	6	947	1042.3	878	1092	5	
230/850BL1	1050	12	33	20	7.5	976	1113.2	886	1184	6	
240/850B	1410	12	42	25	7.5	964.5	1088.9	886	1184	6	
231/850B	2270	12	42	25	12	-	-	904	1306	10	
232/850B	3890	12	42	25	15	-	-	914	1436	12	
239/900L1	623	12	33	20	6	997	1100.5	928	1152	5	
230/900B	1170	12	33	20	7.5	1030	1166.8	936	1244	6	
240/900B	1570	12	42	25	7.5	1017.5	1146.6	936	1244	6	
231/900B	2500	12	42	25	12	-	-	954	1366	10	
239/950	774	12	33	20	7.5	1053.5	1164.4	986	1214	6	
230/950B	1430	12	33	20	7.5	1095.5	1238.2	986	1324	6	
240/950B	1970	12	42	25	7.5	1075	1212.4	986	1324	6	
239/1000L1	916	12	33	20	7.5	1111	1229.3	1036	1284	6	
230/1000B	1580	12	33	20	7.5	-	-	1036	1384	6	
240/1000B	2110	12	42	25	7.5	1129.5	1271.3	1036	1384	6	
239/1060	1090	12	33	20	7.5	1181	1306.1	1096	1364	6	
230/1060BL1	1850	12	42	25	9.5	1200	1368	1104	1456	8	
240/1060B	2450	12	42	25	9.5	-	-	1104	1456	8	
238/1120	536	12	27	16	6	1204	1295	1148	1332	5	
239/1120	1140	12	33	20	7.5	-	-	1156	1424	6	
230/1120B	2160	12	42	25	9.5	1265	1441.3	1164	1536	8	
240/1120BL1	2890	12	42	25	9.5	1262.5	1417.1	1164	1536	8	
238/1180L1	559	12	27	16	6	1264.5	1355.6	1208	1392	5	
239/1180	1390	12	33	20	7.5	1300	1436.3	1216	1504	6	
249/1180	1740	12	42	25	7.5	1301.5	1424.6	1216	1504	6	
240/1180B	3220	12	42	25	9.5	1326	1488.6	1224	1616	8	
239/1250	1600	12	33	20	7.5	-	-	1286	1594	6	
239/1320	1900	12	33	20	7.5	-	-	1356	1684	6	
240/1320B	4320	12	42	25	12	1487	1670.5	1374	1796	10	
239/1400	2230	12	33	20	9.5	-	-	1444	1776	8	
248/1500L1	1660	12	33	20	7.5	1609.5	1724.1	1536	1784	6	
248/1800L1	2830	12	42	25	9.5	1929	2066.2	1844	2136	8	

List of adapter sleeves and withdrawal sleeves

Shaft	BRG	S	N(*)	BRG			S	N	BRG		S	N	BRG
17	20	H304	KM4										
20	25	H305	KM5	21305	22205		H2305	KM5					
25	30	H306	KM6	21306	22206		H2306	KM6					
30	35	H307	KM7	21307	22207		H2307	KM7					
35	40	H308	KM8	21308	22208		H2308	KM8	22308				
40	45	H309	KM9	21309	22209		H2309	KM9	22309				
45	50	H310	KM10	21310	22210		H2310	KM10	22310				
50	55	H311	KM11	21311	22211		H2311	KM11	22311				
55	60	H312	KM12	21312	22212		H2312	KM12	22312				
60	65	H313	KM13	21313	22213		H2313	KM13	22313				
65	70	H314	KM14	21314	22214		H2314	KM14	22314				
70	75	H315	KM15	21315	22215		H2315	KM15	22315				
75	80	H316	KM16	21316	22216		H2316	KM16	22316				
80	85	H317	KM17	21317	22217		H2317	KM17	22317				
85	90	H318	KM18	21318	22218		H2318	KM18	22318	23218			
90	95	H319	KM19	21319	22219		H2319	KM19	22319				
95	100	H320	KM20	21320	22220		H2320	KM20	22320	23220			
100	110	H322	KM22	21322	22222	23022	H2322	KM22	22322	23222			
110	120						H2324	KM24	22324	23224	H3024	KML24	23024
115	130						H2326	KM26	22326	23226	H3026	KML26	23026
125	140						H2328	KM28	22328	23228	H3028	KML28	23028
135	150						H2330	KM30	22330	23230	H3030	KML30	23030
140	160						H2332	KM32	22332	23232	H3032	KML32	23032
150	170						H2334	KM34	22334	23234	H3034	KML34	23034
160	180						H2336	KM36	22336	23236	H3036	KML36	23036
170	190						H2338	KM38	22338	23238	H3038	KML38	23038
180	200						H2340	KM40	22340	23240	H3040	KML40	23040
200	220						H2344H	HM44T	22344	23244	H3044H	HM3044	23044
220	240						H2348H	HM48T	22348	23248	H3048H	HM3048	23048
240	260						H2352H	HM52T	22352	23252	H3052H	HM3052	23052
260	280						H2356H	HM56T	22356	23256	H3056H	HM3056	23056
280	300										H3060H	HM3060	23060
300	320										H3064H	HM3064	23064
320	340										H3068H	HM3068	23068
340	360										H3072H	HM3072	23072
360	380										H3076H	HM3076	23076
380	400										H3080H	HM3080	23080
400	420										H3084H	HM3084	23084
410	440										H3088H	HM3088	23088
430	460										H3092H	HM3092	23092
450	480										H3096H	HM3096	23096
470	500										H30/500H	HM30/500	230/500
500	530										H30/530H	HM30/530	230/530
530	560										H30/560H	HM30/560	230/560
560	600										H30/600H	HM30/600	230/600
600	630										H30/630H	HM30/630	230/630
630	670										H30/670H	HM30/670	230/670
670	710										H30/710H	HM30/710	230/710
710	750										H30/750H	HM30/750	230/750
750	800										H30/800H	HM30/800	230/800

List of adapter sleeves and withdrawal sleeves

Shaft	BRG	S	N(*)	BRG	S	N	BRG	S	N	BRG	S	N	BRG		
17	20														
20	25		/	21305	22205										
25	30		/	21306	22206										
30	35		/	21307	22207										
35	40	AH308	KM9	21308	22208			AH2308	KM9	22308					
40	45	AH309	KM10	21309	22209			AH2309	KM10	22309					
45	50	AHX310	KM11	21310	22210			AHX2310	KM11	22310					
50	55	AHX311	KM12	21311	22211			AHX2311	KM12	22311					
55	60	AHX312	KM13	21312	22212			AHX2312	KM13	22312					
60	65	AH313G	KM14	21313	22213			AH2313G	KM14	22313					
65	70	AH314G	KM15	21314	22214			AHX2314G	KM15	22314					
70	75	AH315G	KM16	21315	22215			AHX2315G	KM16	22315					
75	80	AH316	KM17	21316	22216			AHX2316	KM17	22316					
80	85	AHX317	KM18	21317	22217			AHX2317	KM18	22317					
85	90	AHX318	KM19	21318	22218			AHX2318	KM19	22318					
90	95	AHX319	KM20	21319	22219			AHX2319	KM20	22319					
95	100	AHX320	KM22	21320	22220			AHX2320	KM22	22320					
105	110	AHX322	KM24	21322				AHX2322G	KM24	22322					
115	120							AHX2324G	KM26	22324	AHX3024	KM26	23024		
125	130							AHX2326G	KM28	22326	AHX3026	KM28	23026		
135	140							AHX2328G	KM30	22328	AHX3028	KM30	23028		
145	150							AHX2330G	KM32	22330	AHX3030	KM32	23030		
150	160							AH2332G	KM34	22332	AH3032	KM34	23032		
160	170							AH2334G	KM36	22334	AH3034	KM36	23034		
170	180					AH2236G	KM38	22236	AH2336G	KM38	22336	AH3036	KM38	23036	
180	190					AH2238G	KM40	22238	AH2338G	KM40	22338	AH3038G	KM40	23038	
190	200					AH2240	HM44T	22240	AH2340	HM44T	22340	AH3040G	HM44T	23040	
200	220					AOH2244	HM48T	22244	AOH2344	HM48T	22344	23244	AOH3044G	HM46T	23044
220	240					AOH2248	HM52T	22248	AOH2348	HM52T	22348	23248	AOH3048	HM52T	23048
240	260					AOH2252G	HM56T	22252	AOH2352G	HM56T	22352	23252	AOH3052	HM56T	23052
260	280					AOH2256G	HM3160	22256	AOH2356G	HM3160	22356	23256	AOH3056	HM3060	23056
280	300					AOH2260G	HM3164	22260					AOH3060	HM3064	23060
300	320					AOH2264G	HM3168	22264					AOH3064G	HM3068	23064
320	340												AOH3068G	HM3072	23068
340	360												AOH3072G	HM3076	23072
360	380												AOH3076G	HM3080	23076
380	400												AOH3080G	HM3084	23080
400	420												AOH3084G	HM3088	23084
420	440												AOHX3088G	HM3092	23088
440	460												AOHX3092G	HM3096	23092
460	480												AOHX3096G	HM30/500	23096
480	500												AOHX30/500G	HM30/530	230/500
500	530												AOH30/530	HM30/560	230/530
530	560												AOHX30/560	HM30/600	230/560
570	600												AOHX30/600	HM30/630	230/600
600	630												AOH30/630	HM30/670	230/630
630	670												AOH30/670	HM30/710	230/670
670	710												AOHX30/710	HM30/750	230/710
710	750												AOH30/750	HM30/800	230/750
750	800												AOH30/800	HM30/850	230/800
800	850												AOH30/850	HM30/900	230/850
850	900												AOH30/900	HM30/950	230/900
900	950												AOH30/950	HM30/1000	230/950





Part 6 Housings for spherical roller bearings

Housings for spherical roller bearings

Present in a wide variety of industrial fields, NTN-SNR bearing housings are suitable for all high-capacity applications. Our entire range of bearing housings, combined with NTN-SNR ULTAGE bearings, ensures that you get a unique level of performance.

Part or one-piece bearing housings • Grease lubrication

	<p>SNC two-part plummer block</p> <ul style="list-style-type: none"> • Excellent rigidity and stability under all load conditions • Optimised for improved resistance to vibrations • Improved heat dissipation characteristics • Increased bearing service life • 5 different seal systems • Ready to use, easy to fit • Shaft diameter: 20mm – 160mm
	<p>SD31 two-part plummer block, large size</p> <ul style="list-style-type: none"> • Economical • Suited to heavy machine constructions, roller-crushers, conveyor augers and other machines operating in harsh environments • Shaft diameter: 150mm – 400mm
	<p>SPW/SFCW – one-piece plummer block for heavy loads</p> <ul style="list-style-type: none"> • Suited to highly demanding, heavy industrial environments • Components treated for corrosion protection • Enables rapid replacement of patented inserts • Equipped with sealed spherical roller bearings • Reduced maintenance time and increased productivity • SPW range interchangeable with SN bearing housing units • Shaft diameter: 50mm – 140mm

Part or one-piece bearing housings • Oil lubrication



SNOE oil-lubricated two-part plummer block

- Suited to spherical roller bearings
- Perfectly suited to operating conditions with heavy loads and high rotation speeds
- Material: EN-GJS-600-3 for high rigidity
- Internal distribution of oil via a lubrication ring
- Seal by means of a labyrinth seal system
- Fitted with an oil level indicator
- Possible integration in an oil circulation system (with or without heating)
- Excellent heat dissipation
- Applications: industrial fans, hammer crushers, extraction, steelworks, chemical and petrochemical industries, power plants, ventilation mechanisms, drying systems,



SNOL oil-lubricated two-part plummer block (compact version)

- Suited to spherical roller bearings
- Seal by means of a labyrinth seal system
- Can replace a grease-lubricated two-part plummer block when the rotation speeds are too high or when the operating temperatures risk damaging the bearing
- Interchangeable with the same-size SN bearing housings
- Fitted with an oil level indicator
- Shaft diameter: 60mm – 140mm





Experts & Tools

Part 7 Experts & tools services

• Mounting and dismounting tools	82
• Lub'solutions	83
• Services	84

Mounting & dismantling tools

**Experts
& Tools**

Mounting and dismantling a bearing: these essential stages determine the life span of the installation as well as its correct operation.



Cold mounting:

The tool case for a quick and accurate bearing fitting in complete safety.



Hot mounting:

Induction heating: Practical, simple, safe, environmentally-friendly ...
What else?



Hydraulic mounting:

Precise, effortless with a revolutionary nut, always ready for use thanks to its "back & forth" feature!



Dismounting tools:

Hydraulic or mechanical dismantling:
All kinds of pullers (2 or 3 arms) for a safe and clean operation whatever the position and the size of the bearing.



Instruments:

Simple, safe and precise monitoring of operating machine temperature with a laser pointer thermometer.

And more tools for bearing fitting and handling...

Lub'solutions

Experts & Tools

LUB'SOLUTIONS: we can provide support for your lubrication project from design to installation offering lubricants specially selected for your applications. single-point or multi-point lubrication systems according to your process size and requirements.

Greases

Designed for the demands of your application to ensure your bearings will operate at their best.



Universal



Heavy Duty



Vib



High Temp



Ultra High Temp



Food



High Speed+



Chain Oil



Automatic single-point lubricators

We have the right lubricator for all your applications thanks to our wide range of technologies combined with our top-quality bearing lubricants. All you need is here!



Centralised lubrication systems

For the oil or grease central lubrication requirements of your industrial processes, we can provide all types of pumps and accessories: Volumetric, Progressive, Air-oil spray, Multi-line or Dual line. You have it all!



Lubrication system design and set-up

LUB'SOLUTIONS also provide experts to support you in your lubrication turn-key projects, from design to set-up. Lubrication has never been so easy!

Services

Experts & Tools

Experts & Tools: the NTN-SNR team of experts can support your organisation to obtain the best performance from your bearings and your operations



Training

Improve the skills of your maintenance technicians and designers in bearing selection and maintenance. Whether at our training school or on your premises with our BEBOX van, we can provide made-to-measure training courses covering both theory and practice, because all customers are different.

Our teaching methods make the difference!



Damaged bearing diagnosis

Let our experts determine the causes of your bearing failures in our lab or on your site. Our reactivity and advice can provide the keys to your improvements... and track your bearing diagnosis request on the NTN-SNR website.



Bearing reconditioning & Machine tool spindle repair

Have your industrial bearings reconditioned by a company used to renovating aircraft jet engine or bullet train bearings. And for a fraction of their brand new cost!



Technical assistance for bearings and lubrication systems

Rely on our experts to supervise your maintenance operations: bearing dismounting and fitting, lubrication system set-up and improvement, vibration analysis...



Maintenance audit

Benefit from a unique appraisal of your maintenance organisation, performed by our plant maintenance managers. Gain productivity thanks to a pragmatic action plan resulting from a peer-to-peer approach.



Tool rent

Experts & Tools offers a wide range of large bearing maintenance tools for rent: induction heaters, hydraulic nuts, pumps...



contatto
contatto

お問い合わせ

contacto
contacto

contact
contact

www.ntn-snr.com

الاتصال ب

contacto
contacto

联系我们
Lian Xi Wo Men

KONTAKT
Kontakt

AUTOMOTIVE / AEROSPACE / INDUSTRY

Distributed by: